



elcometer[®]
NDT

Ultrasonic NDT Gauges

Introducing the NDT Range

With their ergonomic sealed metal cases, water and dustproof membrane keypads and a wide range of ultrasonic transducer probes, capable of measuring materials at temperatures up to 340°C (650°F), the Elcometer NDT corrosion, precision and flaw detection gauges are the ideal ultrasonic instruments for measuring wall thicknesses and detecting a wide range of flaws in a broad range of industry applications, including the oil & gas, marine, power and civil engineering sectors.

Designed for your application

The Elcometer NDT philosophy is to offer customers what they want.

Velocity Gauges (VG)

Simple hand-held device to determine the speed of sound (velocity) of an unknown material or as a device to assess the homogeneity of a component of known thickness.

Corrosion Gauges (CG & UG)

From the low cost CG10, providing users with the ability to measure up to 500mm (20") of a user defined material; to the state of the art model CG100ABDL+, complete with an A & B Scan display, colour screen, 210,000 reading memory and the ability to measure the coating and material thickness individually or at the same time, Elcometer NDT has the gauge to meet your specific inspection needs.

Precision Gauges (PG)

Simple accuracy on thin substrates using a single channel transducer and interface-echo measurement method.

Flaw Detectors (FD)

Small, hand-held, value for money flaw detectors provide users with all the measurement tool kits expected from larger, more expensive products on the market, as well as the benefits of high end thickness gauges.

Sonic Gauges (SG)

Easy to use gauges specially designed for the automotive industry.

Bolt Tension Gauges (BG)

Ultrasonically measures the elongation produced by tightening a threaded fastener.

The measurement principle

Based upon the property that sound waves reflect off the boundary between dissimilar material densities; an ultrasonic sound pulse, generated by a transducer, travels through the test material and is reflected off the change in density boundary - normally the back wall of the sample. This returning sound wave is picked up by the same transducer and the gauge displays the material thickness.



FD700DL+ in carry case for additional protection

Quality as Standard

The confidence we have in our products mean we are delighted to provide a comprehensive 2 year warranty on Elcometer NDT gauges and 90 days on transducers, against defects caused by faulty design, materials or workmanship.

2 YEAR
WARRANTY

Measurement modes explained

There are a wide range of measurement modes available within the Elcometer NDT Series, the number of modes available vary between the models but normally increase as the model number increases and include:



Each gauge is sealed against the elements

The material thickness equals the velocity of sound in the material multiplied by half the time of travel of the sound pulse from and to the transducer. The velocity of sound in the material is set up within the gauge by the user.

Pulse - Echo Mode (PE):

The normal display mode, measures the total thickness from the base of the transducer probe to the material density boundary (typically the back wall). Ideal for pit and flaw detection.

Interface - Echo Mode (IE):

More accurate than the PE mode, IE displays the total thickness from the top surface to the material density boundary - i.e. ignores the couplant thickness.

Echo - Echo Mode (EE):

Also known as the ThruPaint™ Mode, EE ignores the coating thickness, displaying the material thickness from the top surface of the material to the material density boundary.

Echo - Echo Verify Mode (EEV):

The echo-echo verify mode measures by comparing the values between 3 reflections and is mainly used to eliminate errors from surface coatings and to make measurements in multiple layered materials.

Coating Only Mode (CT):

Displays the thickness of the coating applied to the material.

Pulse - Echo Temp Comp Mode (PETP):

Similar to the PE mode, PETP takes into account and compensates for the variations in measurement caused by temperature variations.

Pulse - Echo Coating Mode (PECT):

Displays both the material thickness (PE) and the coating thickness (CT) at the same time.

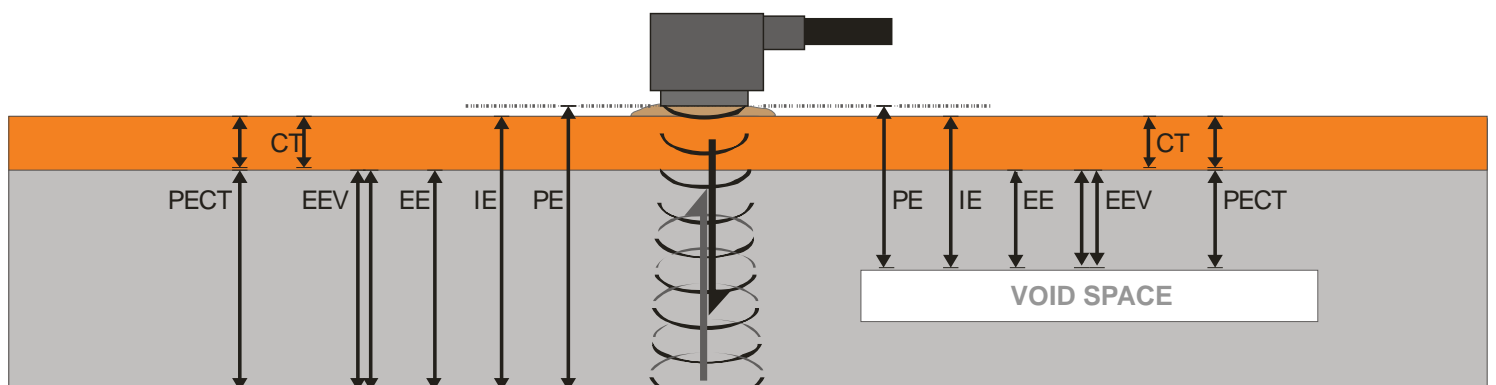

Display Modes

The Elcometer NDT Series has a number of display modes available to help the user establish the most accurate thickness value. The modes available vary depending upon the gauge selected and include:

Material Thickness Digits Display

The standard display on all models, this displays the numerical thickness value in either millimetres (MM) or inches (IN).

Scan Bar Display

A linear graphic display which allows users to graphically monitor changes in thickness readings. As the scale range can be adjusted by the user, this display is ideal for observing tiny variations in material thicknesses.

B-Scan Display

A time based cross sectional 2D block view of the thickness provides a graphical view of the material thickness - ideal for relative depth analysis.

A-Scan Display; Full Wave (RF)

The A-Scan display shows the sine wave created by the reflected sound, or oscillation, from the material being measured. In RF mode the full wave form is displayed.

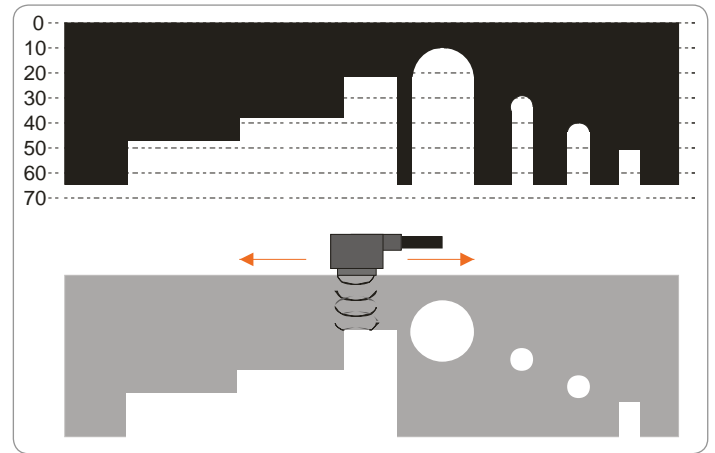

Cross Sectional B-Scan Display (graphical representation)

A-Scan Display; Rectified (+ or -)

Users can select to view either the positive or the negative cycle of the full waveform (RF). This rectified (RECT) display shows the amplitude of the echo versus the transit time.

Flaw Mode

Available on the CG100ABDL+ & FD700+ series, this mode enables inspectors to locate porosity, defects, inclusions and cracks in a variety of test materials and during weld inspections.

The sound wave is introduced into the test material at a specific angle, and converted from a longitudinal wave into a shear wave.

The introduction at specific angles enables inspectors to steer the sound wave in a specific direction according to the position and location of specific types of defects.



PECT mode on the CG100ABDL displaying material & coating thickness with scan bar

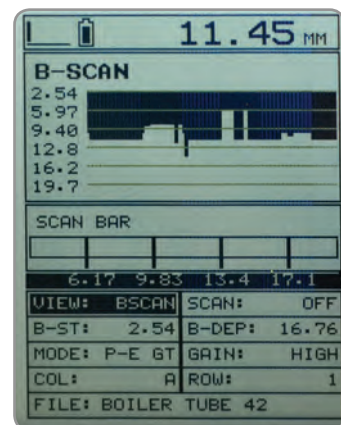

Cross Sectional B-Scan mode on the CG70BDL displaying material thickness, scan bar & grid logging

Some Key Features

Elcometer NDT thickness gauges have a number of useful features to aid the user.

The features available vary depending on the model selected, and include:

Repeatability / Stability Indicator

Consisting of 6 vertical bars, when all the bars are fully illuminated and the last digit on the digital thickness value is stable, the gauge is reliably measuring the material thickness.

Differential Mode

Once a user defined nominal thickness value has been set, the gauge will display the +/- thickness difference from the nominal value entered.

Minimum Thickness Alarm Mode

If the measurement falls below a user defined target value a red LED will light and the beeper sounds. A green LED will light to indicate an acceptable thickness.

Limit Alarm Mode

The user can define minimum and maximum thickness limits. If the measurement falls outside the upper or lower limit a red LED will light and the beeper sounds. A green LED will light to indicate an acceptable thickness.

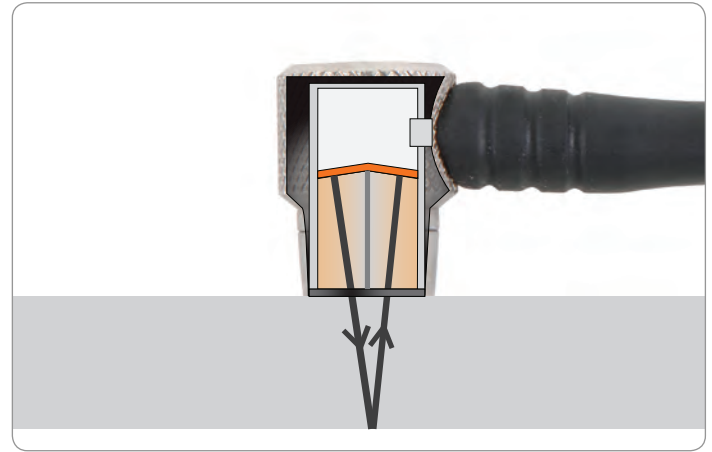

Dual Element Transducer showing V-Path Correction

High Speed Scan with Minimum Thickness Display

By significantly increasing the measurement refresh rate this mode allows the user to make scanned passes over the test material.

The smallest thickness value is held in memory and displayed when scanning is complete.

This feature can also be used in conjunction with the minimum & maximum limit alarm feature (model dependant).

V-Path Correction

Dual element transducers consist of a probe with two crystals (one to transmit and one to receive the sound pulse). The crystals are separated by an acoustic barrier - generating a 'V-shaped' sound path as the sound travels from one element to the other.

As the time / thickness relationship is non-linear, V-path correction is used to compensate for this error.

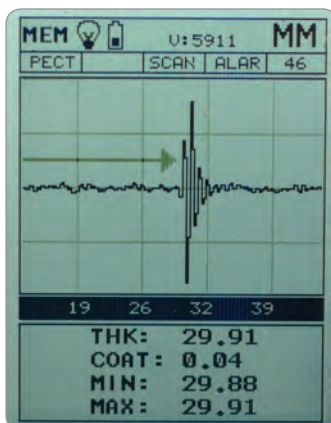

A-Scan (RF) mode on the CG100ABDL displaying material & coating thickness

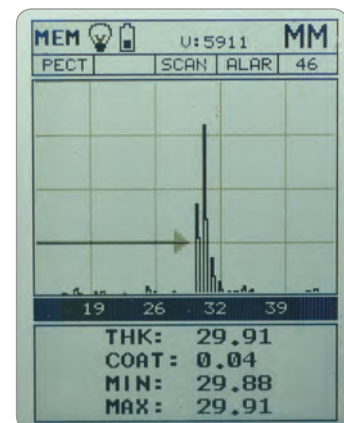

A-Scan +ve RECT mode on the CG100ABDL displaying material & coating thickness

VG10

Velocity Gauge

The VG10 is a simple hand-held velocity gauge.

Ideal for determining the speed of sound (velocity) of an unknown material or as a device to assess the homogeneity of a component of known thickness.

Placing the transducer probe on the material the gauge will display the speed of sound of that material at that point.

The high speed scan mode allows the operator to drag the probe across the material and when the probe is lifted from the material, the gauge displays the fastest velocity recorded during the scan.

Definition: HOMOGENEITY (noun)
[hoh-muh-juh-nee-i-tee]

- 1: of the same or a similar kind or nature
- 2: of uniform structure or composition throughout



Advantages

- Durable gauge and probe construction
- Tough, impact, water, dust & petroleum product resistant
- Up to 200 hours battery life
- Multi-function 4.5 digit LCD display, backlit for use in poor light conditions
- Backlight is selectable on/off/auto (illuminates only when taking a measurement)
- Measurements in metres/second and inches/microsecond
- Bar graph indicates stability of reading



See Page 40
for full range
of Transducers

Model & Part Number	VG10
Display Mode: Material velocity digits display	•
Measurement Mode¹	PE
Measurement Rate Manual: Scan mode:	4 readings per second 16 readings per second
Measuring Range²	0.63 - 500mm (0.025 - 19.999 inches)
Measurement Accuracy²	±0.01mm (±0.001 inches)
Measurement Resolution	0.01mm (0.001 inches)
Velocity Calibration Range	1250 - 10,000m/s 0.0492 - 0.3937in/μs
Additional Features:³ High speed scan mode	•
Transducer Probe Type	dual element
Transducer Frequency Range	1 - 10MHz
V-path / dual path error correction	automatic
Probe Zero	Manual (via integrated probe disk)
Display	12.7mm (0.5 inch) high digits
Units (selectable)	metres/second or inches/microsecond
LED Backlight	on / off / auto
Repeatability / Stability Indicator	•
Battery Type	2 x AA alkaline
Battery Life (approximate)	200 hours
Low Battery Indicator	•
Battery Save Mode	auto
Operating Temperature	-30 to 50°C (-20 to 120°F)
Size (w x h x d)	63.5 x 114.3 x 31.5mm 2.5 x 4.5 x 1.24 inches
Weight (including batteries)	284g (10oz)
Aluminium case design with gasket sealed end caps and waterproof membrane keypad	•
Transducer Connector Type	LEMO
RS232 Interface	for programming only
Packing List	Elcometer NDT VG10 gauge, couplant, carry case, user manual, test certificate, 2 x AA batteries

¹ PE: Pulse-Echo Mode; See page 3 for further information

² Measuring range & accuracy depends on material, surface conditions and the transducer selected

³ See page 5 for a full explanation of the features

CG10 & CG20

Thickness Gauges

The CG10 and CG20 are fixed velocity gauges making them affordable precision tools that require no special training to operate.

The CG10 will hold a single, user programmable velocity. Pre-calibrated to steel, for immediate inspection, the CG10 is the ideal model where one material is being tested day after day.

Whilst the gauge is supplied ready to measure steel the velocity can be quickly changed using the simple software program which is supplied with each unit, allowing other materials to be measured.

The CG20 has two user programmable velocities and 8 pre-programmed velocities to measure the thickness of aluminium, steel, stainless steel, cast iron, plexiglass, PVC, polystyrene and polyurethane - making the CG20 an ideal model for the person who tests a few different materials regularly.

These small, lightweight, water resistant units are easy to use and designed for the harshest environments.



Advantages

- Ready to use, straight from the box
- Ideal for basic thickness measurements
- Durable gauge and probe construction
- Large backlight LED display
- Tough, impact, water, dust & petroleum product resistant
- Up to 200 hours battery life



See Page 40
for full range
of Transducers

Model & Part Number	CG10	CG20
Display Mode: Material thickness digits display	•	•
Measurement Mode ¹	PE	PE
Measurement Rate Manual:	4 readings per second	4 readings per second
Measuring Range ²	0.63 - 500mm (0.025 - 19.999 inches)	0.63 - 500mm (0.025 - 19.999 inches)
Measurement Accuracy ²	±0.01mm (±0.001 inches)	±0.01mm (±0.001 inches)
Measurement Resolution	0.01mm (0.001 inches)	0.01mm (0.001 inches)
Velocity Calibration Range	1250 - 10,000m/s 0.0492 - 0.3937in/μs	1250 - 10,000m/s 0.0492 - 0.3937in/μs
Additional Features	1 programmable velocity, pre-calibrated for steel	2 user programmable & 8 pre-calibrated velocities for: aluminium, cast iron, plexiglass, polystyrene, polyurethane, PVC, stainless steel & steel
Transducer Probe Type	dual element	dual element
Transducer Frequency Range	1 - 10MHz	1 - 10MHz
V-path / dual path error correction	automatic	automatic
Probe Zero	manual (via integrated probe disk)	manual (via integrated probe disk)
Display	12.7mm (0.5 inches) high digits	12.7mm (0.5 inches) high digits
Units (selectable)	mm or inches	mm or inches
LED Backlight	on / off / auto	on / off / auto
Repeatability / Stability Indicator	•	•
Battery Type	2 x AA alkaline	2 x AA alkaline
Battery Life (approximate)	200 hours	200 hours
Low Battery Indicator	•	•
Battery Save Mode	auto	auto
Operating Temperature	-30 to 50°C (-20 to 120°F)	-30 to 50°C (-20 to 120°F)
Size (w x h x d)	63.5 x 114.3 x 31.5mm 2.5 x 4.5 x 1.24 inches	63.5 x 114.3 x 31.5mm 2.5 x 4.5 x 1.24 inches
Weight (including batteries)	284g (10oz)	284g (10oz)
Aluminium case design with gasket sealed end caps, waterproof membrane keypad	•	•
Transducer Connector Type	LEMO	LEMO
RS232 Interface	for programming only	for programming only
Packing List	Elcometer NDT CG10 gauge, couplant, carry case, user manual, test certificate, 2 x AA batteries, software, transfer cable	Elcometer NDT CG20 gauge, couplant, carry case, user manual, test certificate, 2 x AA batteries, software, transfer cable

¹ PE: Pulse-Echo Mode; See page 3 for further information

² Measuring range & accuracy depends on material, surface conditions and the transducer selected

CG30, CG50 & CG50DL

Thickness Gauges

The CG30, CG50 and CG50DL are easy to use, versatile gauges, quickly calibrated on site by the user to give reliable, accurate thickness measurements on a wide variety of material substrates.

Taking 16 readings per second the high speed scan mode allows the user to quickly scan an area of material for defects or to identify its thinnest point, ideal for pipelines or large test surfaces.

The differential mode on the CG50 & CG50DL allows the user to select a nominal thickness value, the gauge will then display the positive or negative (\pm) difference from the nominal value entered.

The built-in minimal thickness alarm mode illuminates a red LED and an audible alarm sounds when a measurement falls below the user defined target value.

The CG50DL offers full data logging and stores up to 1,000 readings. Complete with free data management software, readings can be directly downloaded into spreadsheets using the RS232 dataport, for full analysis and reporting.



Advantages

- Multi calibration options: 1 point, 2 point and speed of sound for optimal accuracy
- High speed scan mode: 16 readings per second
- Differential and minimal thickness alarm modes
- Data output and storage: 1,000 readings and wave forms
- Wide range of interchangeable transducers
- Easy to use menu structure
- Tough, impact, water, dust & petroleum product resistant
- Up to 200 hours battery life



See Page 40
for full range
of Transducers

Specifications

CG30, CG50 & CG50DL

Model & Part Number	CG30	CG50	CG50DL
Display Mode: Material thickness digits display	•	•	•
Measurement Mode¹	PE	PE	PE
Measurement Rate Manual: Scan Mode:	4 readings per second 16 readings per second	4 readings per second 16 readings per second	4 readings per second 16 readings per second
Measuring Range²	0.63 - 500mm (0.025 - 19.999 inches)	0.63 - 500mm (0.025 - 19.999 inches)	0.63 - 500mm (0.025 - 19.999 inches)
Measurement Accuracy²	±0.01mm (±0.001 inches)	±0.01mm (±0.001 inches)	±0.01mm (±0.001 inches)
Measurement Resolution	0.01mm (0.001 inch)	0.01mm (0.001 inch)	0.01mm (0.001 inch)
Velocity Calibration Range	1250 - 10,000m/s 0.0492 - 0.3937in/μs	1250 - 10,000m/s 0.0492 - 0.3937in/μs	1250 - 10,000m/s 0.0492 - 0.3937in/μs
Additional Features:³ High speed scan mode Differential mode Minimum thickness alarm mode	•	• • •	• • •
Data logging			1,000 readings, sequential
Calibration Options	single & two point	single & two point	single & two point
Transducer Probe Type	dual element	dual element	dual element
Transducer Frequency Range	1 - 10MHz	1 - 10MHz	1 - 10MHz
V-path / dual path error correction	automatic	automatic	automatic
Probe Zero	manual (via integrated probe disk)	manual (via integrated probe disk)	manual (via integrated probe disk)
Display	12.7mm (0.5 inch) high digits	12.7mm (0.5 inch) high digits	12.7mm (0.5 inch) high digits
Units (selectable)	mm or inches	mm or inches	mm or inches
LED Backlight	on / off / auto	on / off / auto	on / off / auto
Repeatability / Stability Indicator	•	•	•
Battery Type	2 x AA alkaline	2 x AA alkaline	2 x AA alkaline
Battery Life (approximate)	200 hours	200 hours	200 hours
Low Battery Indicator	•	•	•
Battery Save Mode	auto	auto	auto
Operating Temperature	-30 to 50°C (-20 to 120°F)	-30 to 50°C (-20 to 120°F)	-30 to 50°C (-20 to 120°F)
Size (w x h x d)	63.5 x 114.3 x 31.5mm 2.5 x 4.5 x 1.24 inches	63.5 x 114.3 x 31.5mm 2.5 x 4.5 x 1.24 inches	63.5 x 114.3 x 31.5mm 2.5 x 4.5 x 1.24 inches
Weight (including batteries)	284g (10oz)	284g (10oz)	284g (10oz)
Aluminium case design with gasket sealed end caps, waterproof membrane keypad	•	•	•
Transducer Connector Type	LEMO	LEMO	LEMO
RS232 Interface	•	•	•
Packing List	Elcometer NDT CG30 gauge, couplant, carry case, user manual, test certificate, 2 x AA batteries	Elcometer NDT CG50 gauge, couplant, carry case, user manual, test certificate, 2 x AA batteries	Elcometer NDT CG50DL gauge, couplant, carry case, user manual, test certificate, 2 x AA batteries, software, transfer cable

¹ PE: Pulse-Echo Mode; See page 3 for further information

² Measuring range & accuracy depends on material, surface conditions and the transducer selected

³ See page 5 for a full explanation of the features

CG60 & CG60DL

Thickness Gauges

Ideal for inspecting pipes, storage tanks and other metal structures, the CG60 & CG60DL feature both Pulse-Echo (PE) and Echo-Echo mode (EE) ThruPaint™ technology.

Offering all the features and benefits of the CG50, the CG60 series is designed to ignore the coating thickness giving a true material thickness value.

Designed to ignore applied coatings up to 2mm (80mils) thick on metal substrates, the CG60 is ideal for identifying internal corrosion that isn't visible due to the applied coating.

The CG60 & CG60DL also offer high speed scanning, taking 16 readings per second, making quick scanned passes over the test material. With the lowest thickness value held in memory and displayed when the scanning is complete.

Once a user defined nominal thickness value is set the differential mode will display the +/- thickness difference from the nominal value entered.

The built-in minimal thickness alarm mode illuminates a red LED and an audible alarm sounds when a measurement falls below the user defined target value.

The CG60DL offers full data logging and storing of up to 1,000 readings. Complete with free data management software, readings can be directly downloaded into spreadsheets using the RS232 dataport, for full analysis and reporting.



Advantages

- Range of display & measurement options: Pulse-Echo, Echo-Echo ThruPaint™ technology
- Adjustable gain: -30dB to 70dB range
- Multiple calibration and material selection options
- High speed scan mode: 16 readings per second
- Differential and minimal thickness alarm modes
- Data output and storage: 1,000 readings and wave forms
- Data management software



See Page 40
for full range
of Transducers

Model & Part Number	CG60	CG60DL
Display Mode: Material thickness digits display	•	•
Measurement Mode ¹	PE & EE (ThruPaint™)	PE & EE (ThruPaint™)
Measurement Rate Manual: Scan Mode:	4 readings per second 16 readings per second	4 readings per second 16 readings per second
Measuring Range ²	PE: 0.63 - 500mm (0.025 - 19.999 inches) EE: 2.54 - 25.4mm (0.100 - 1.00 inches)	PE: 0.63 - 500mm (0.025 - 19.999 inches) EE: 2.54 - 25.4mm (0.100 - 1.00 inches)
Measurement Accuracy ²	±0.01mm (±0.001 inch)	±0.01mm (±0.001 inch)
Measurement Resolution	0.01mm (0.001 inches)	0.01mm (0.001 inches)
Velocity Calibration Range	1250 - 10,000m/s 0.0492 - 0.3937in/μs	1250 - 10,000m/s 0.0492 - 0.3937in/μs
Additional Features: ³ High speed scan mode Differential mode Minimum thickness alarm mode	• • •	• • •
Data logging		1,000 readings (10 batches of 100 readings)
Calibration Options	single & two point	single & two point
Transducer Probe Type	dual element	dual element
Transducer Frequency Range	1 - 10MHz	1 - 10MHz
V-path / dual path error correction	automatic	automatic
Probe Zero	manual (via integrated probe disk)	manual (via integrated probe disk)
Display	12.7mm (0.5 inch) high digits	12.7mm (0.5 inch) high digits
Units (selectable)	mm or inches	mm or inches
LED Backlight	on / off / auto	on / off / auto
Repeatability / Stability Indicator	•	•
Battery Type	2 x AA alkaline	2 x AA alkaline
Battery Life (approximate)	200 hours	200 hours
Low Battery Indicator	•	•
Battery Save Mode	auto	auto
Operating Temperature	-30 to 50°C (-20 to 120°F)	-30 to 50°C (-20 to 120°F)
Size (w x h x d)	63.5 x 114.3 x 31.5mm 2.5 x 4.5 x 1.24 inches	63.5 x 114.3 x 31.5mm 2.5 x 4.5 x 1.24 inches
Weight (including batteries)	284g (10oz)	284g (10oz)
Aluminium case design with gasket sealed end caps, waterproof membrane keypad	•	•
Transducer Connector Type	LEMO	LEMO
RS232 Interface	•	•
Packing List	Elcometer NDT CG60 gauge, couplant, carry case, user manual, test certificate, 2 x AA batteries	Elcometer NDT CG60DL gauge, couplant, carry case, user manual, test certificate, 2 x AA batteries, software, transfer cable

¹ PE: Pulse-Echo Mode, EE: Echo-Echo (ThruPaint™) Mode; See page 3 for further information

² Measuring range & accuracy depends on material, surface conditions and the transducer selected

³ See page 5 for a full explanation of the features

CG70BDL & CG70ABDL

Thickness Gauges

The CG70 series with its large easy to read display provides users with A and B-Scan options for accurate interpretation of measurements.

Both CG70 gauges offer a 2D cross sectional block view providing a graphical representation of a material's thickness, ideal for accurate analysis and identification of pits and corroded areas.

The CG70ABDL also features an A-Scan display, allowing users to fully interpret and control measurement readings. The user can select to view either the full waveform (RF) or the rectified waveform (RECT) showing either the positive or the negative cycle of the full waveform.

Taking 32 readings per second in scan mode, the internal data logger stores up to 12,000 readings together with their waveforms. RS232 output to the Elcometer NDT data management software allows ease of analysis and professional reporting.

The CG70 series has 64 user definable setups and works with a wide range of transducers which can be selected from the gauges internal menu.

The gain control function in Echo-Echo mode automatically adjusts the amplitude of the received echo, but it can be overridden using the selectable low, medium and high gain options to suit the properties of the material being measured, ideal for difficult applications.



Advantages

- Range of display & measurement options: Pulse-Echo, Echo-Echo ThruPaint™ technology
- Multiple calibration and material selection options
- Adjustable gain: -30dB to 70dB range
- Automatic gain control (AGC)
- 64 User definable setups
- High speed scan: 32 readings per second
- Differential and minimal thickness alarm modes
- Data output and storage: 12,000 readings and waveforms or B-Scans
- Data management software



See Page 40
for full range
of Transducers

Model & Part Number	CG70BDL	CG70ABDL
Display Mode: Material thickness digits display B-Scan cross sectional display Combined B-Scan and digits display Scan bar display A-Scan display	• • • •	• • • • + Rectified, - Rectified, Full Waveform (RF)
Measurement Mode¹	PE & EE (ThruPaint™)	PE & EE (ThruPaint™)
Measurement Rate Manual: Scan mode Scan bar display	4 readings per second 32 readings per second 6 readings per second	4 readings per second 32 readings per second 6 readings per second
Measuring Range²	PE: 0.63 - 254mm (0.025 - 9.999 inches) EE: 1.27 - 102mm (0.05 - 4.00 inches)	PE: 0.63 - 254mm (0.025 - 9.999 inches) EE: 2.54 - 102mm (0.100 - 4.00 inches)
Measurement Accuracy²	±0.01mm (±0.001 inches)	±0.01mm (±0.001 inches)
Measurement Resolution	0.01mm (0.001 inches)	0.01mm (0.001 inches)
Velocity Calibration Range	1250 - 9,999m/s (0.0492 - 0.3937in/μs)	1250 - 10,000m/s (0.0492 - 0.3936in/μs)
Additional Features:³ High speed scan mode Differential mode Limit alarm mode	• • •	• • •
B-Scan display speed	15 seconds per screen	15 seconds per screen
Flaw Mode		Basic prove-up flaw detection using single element angle beam transducers
Calibration Setups	6 factory & 64 user-definable setups transferrable to and from a PC archive	6 factory & 64 user-definable setups transferrable to and from a PC archive
Gates		<ul style="list-style-type: none"> PE: 1 gate; EE: 2 gates, 1 gate with hold off Adjustable threshold
Pulser Type	square wave pulser	square wave pulser with adjustable pulse width (spike, thin, wide)
Gain	PE: selectable low, medium or high gain EE: automatic gain control (AGC)	manual or automatic gain control (AGC) with 40dB range (depending on mode selected)
Timing	20MHz with ultra low power 8 bit digitizer	20MHz with ultra low power 8 bit digitizer
Data Logging	<ul style="list-style-type: none"> 12,000 readings with waveform sequential and grid logging Alpha numeric batch identification OBSTRUCT indicates inaccessible locations 	<ul style="list-style-type: none"> 12,000 readings with waveform sequential and grid logging Alpha numeric batch identification OBSTRUCT indicates inaccessible locations
Calibration Options	single, two point, velocity & material type	single, two point, velocity & material type
Transducer Probe Type	dual element	dual element
Transducer Frequency Range	1 - 10MHz	1 - 10MHz
Transducer Recognition	manual - selectable from a list	manual - selectable from a list
V-path / dual path error correction	automatic	automatic
Probe Zero	manual (via integrated probe disk)	manual (via integrated probe disk)
Display	1/8 VGA (greyscale) 62 x 45.7mm (2.4 x 1.8 inches) viewable area	1/8 VGA (greyscale) 62 x 45.7mm (2.4 x 1.8 inches) viewable area
Units (selectable)	mm or inches	mm or inches
LED Backlight	on / off / auto	on / off / auto
Repeatability / Stability Indicator	•	•
Battery Type	3 x AA alkaline	3 x AA alkaline
Battery Life (approximate)	200 hours	200 hours
Low Battery Indicator	•	•
Battery Save Mode	auto	auto
Operating Temperature	-10 to 60°C (14 to 140°F)	-10 to 60°C (14 to 140°F)
Size (w x h x d)	63.5 x 165.0 x 31.5mm (2.5 x 6.5 x 1.24 inches)	63.5 x 165.0 x 31.5mm (2.5 x 6.5 x 1.24 inches)
Weight (including batteries)	383g (13.5oz)	383g (13.5oz)
Aluminium case design with gasket sealed end caps, waterproof membrane keypad	•	•
Transducer Connector Type	LEMO	LEMO
RS232 Interface	Bi-directional	Bi-directional
Packing List	Elcometer NDT CG70BDL gauge, couplant, carry case, user manual, test certificate, 3 x AA batteries, software, transfer cable	Elcometer NDT CG70ABDL gauge, couplant, carry case, user manual, test certificate, 3 x AA batteries, software, transfer cable

¹ PE: Pulse-Echo Mode, EE: Echo-Echo (ThruPaint™) Mode; See page 3 for further information

² Measuring range & accuracy depends on material, surface conditions and the transducer selected

³ See page 5 for a full explanation of the features

CG100B, CG100BDL, CG100ABDL & CG100ABDL+

The most advanced in the Elcometer NDT range, these easy to use corrosion gauges provide inspectors with all the features necessary to accurately measure the material and coating thickness at the same time.

Offering a full range of measurement modes including: Pulse-Echo Temp Comp Mode (PETP) and Coating Only Mode (CT) to Pulse-Echo Coating Mode (PECT), the CG100 range allows the inspector to choose the right tool for the job.

Featuring automatic gain control (AGC) for ease of use or manual adjustment (-30dB to 70dB) to increase the amplitude of the received echo to suit the material properties, the CG100 series are ideal gauges for all applications.

The time corrected gain (TCG) feature automatically compensates for sound attenuation through a material, further increasing the performance of the gauge.

Built-in Gates allow users to set the measurement parameters either on or between waveforms, bypassing any surface echoes or noise from the material.

Threshold adjustment allows users to adjust the sensitivity of the gauge to detect signals with lower amplitudes.

The CG100BDL, CG100ABDL & CG100ABDL+ stores up to 16,000 readings with individual waveforms in alpha numeric batches with full data logging via RS232 data output to Elcometer NDT data management software.

With its high contrasting colour display the CG100ABDL+ has a refresh rate of 120Hz providing users with an instant measurement response.



See Page 40
for full range
of Transducers

Thickness Gauges



Advantages

- Range of display & measurement options: Pulse-Echo, Echo-Echo, Pulse-Echo Temp, Comp Mode (PETP), Coating Only Mode (CT), Pulse-Echo Coating Mode (PECT)
- Adjustable gain: -30dB to 70dB range
- Automatic gain control (AGC)
- Time corrected gain (TCG)
- Gate control
- Threshold adjustment
- 64 User defined setups
- Multiple language display
- Multiple calibration and material selection options
- High speed scan mode: 32 readings per second
- Differential and minimal thickness alarm modes
- Data output and storage: 16,000 readings and waveforms or B-Scans
- Data management software



CG100B, CG100BDL, CG100ABDL & CG100ABDL+

Model & Part Number	CG100B	CG100BDL
Display Mode: Material thickness digits display B-Scan cross sectional display Combined B-Scan and digits display Scan bar display Coating thickness display A-Scan display	• • • • •	• • • • •
Measurement Mode ¹	PE, PETP (Temp Compensation), EE (ThruPaint™), EEV, CT (Coating) & PECT	PE, PETP (Temp Compensation), EE (ThruPaint™), EEV, CT (Coating) & PECT
Measurement Rate Manual: Scan mode Scan bar display	4 readings per second 50 readings per second 6 readings per second	4 readings per second 50 readings per second 6 readings per second
Measuring Range ²	PE: 0.63 - 508mm (0.025 - 19.999 inches) PETP: 0.63 - 508mm (0.025 - 19.999 inches) EE: 2.54 - 102mm (0.100 - 4.000 inches) EEV: 1.27 - 25.4mm (0.050 - 1.000 inches) CT: 0.01 - 2.54mm (0.001 - 0.100 inches) PECT: 0.63 - 508mm (0.025 - 19.999 inches) PECT: 0.01 - 2.54mm (0.001 - 0.100 inches)	PE: 0.63 - 508mm (0.025 - 19.999 inches) PETP: 0.63 - 508mm (0.025 - 19.999 inches) EE: 2.54 - 102mm (0.100 - 4.000 inches) EEV: 1.27 - 25.4mm (0.050 - 1.000 inches) CT: 0.01 - 2.54mm (0.001 - 0.100 inches) PECT: 0.63 - 508mm (0.025 - 19.999 inches) PECT: 0.01 - 2.54mm (0.001 - 0.100 inches)
Measurement Accuracy ²	±0.01mm (±0.001 inches)	±0.01mm (±0.001 inches)
Measurement Resolution	0.01mm (0.001 inches)	0.01mm (0.001 inches)
Velocity Calibration Range	1250 - 13,995m/s (0.0492 - 0.5510in/ms)	1250 - 13,995m/s (0.0492 - 0.5510in/ms)
Additional Features: ³ High speed scan mode Differential mode Limit alarm mode	• • •	• • •
B-Scan display speed	15 seconds per screen	15 seconds per screen
Flaw Mode		
Calibration Setups	6 factory & 64 user-definable setups transferrable to and from a PC archive	6 factory & 64 user-definable setups transferrable to and from a PC archive
Gates		
Damping		
Pulser Type	dual square wave pulsers up to 140Hz pulse repetition rate	dual square wave pulsers up to 140Hz pulse repetition rate
Gain	time corrected gain (TCG), automatic gain control (AGC) with 110dB range (limited), or selectable gain: vlow, low, medium hi or vhi	time corrected gain (TCG), automatic gain control (AGC) with 110dB range (limited), or selectable gain: vlow, low, medium hi or vhi
Timing	precision 25MHz TCXO with single shot 100MHz 8bit ultra low power 8 bit digitizer	precision 25MHz TCXO with single shot 100MHz 8bit ultra low power 8 bit digitizer

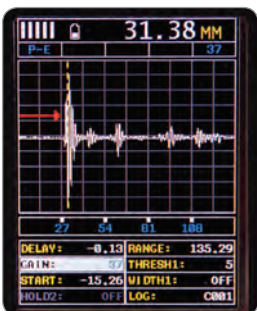

PE

Pulse - Echo Mode

The normal display mode, measures the total thickness from the base of the transducer probe to the material density boundary (typically the back wall). Ideal for pit and flaw detection.



PETP

Pulse - Echo Temp Comp Mode

Similar to the PE mode, PETP takes into account and compensates for the variations in measurement caused by temperature variations.

Specifications

CG100ABDL	CG100ABDL+	Model & Part Number
<ul style="list-style-type: none"> • • • • + Rectified, - Rectified, Full Waveform (RF)	<ul style="list-style-type: none"> • • • • + Rectified, - Rectified, Full Waveform (RF)	Display Mode: Material thickness digits display B-Scan cross sectional display Combined B-Scan and digits display Scan bar display Coating thickness display A-Scan display
PE, PETP (Temp Compensation), EE (ThruPaint™), EEV, CT (Coating) & PECT	PE, PETP (Temp Compensation), EE (ThruPaint™), EEV, CT (Coating) & PECT	Measurement Mode¹
4 readings per second 50 readings per second 6 readings per second	4 readings per second 32 readings per second 6 readings per second	Measurement Rate Manual: Scan mode Scan bar display
PE: 0.63 - 508mm (0.025 - 19.999 inches) PETP: 0.63 - 508mm (0.025 - 19.999 inches) EE: 1.27 - 102mm (0.050 - 4.000 inches) EEV: 1.27 - 25.4mm (0.050 - 1.000 inches) CT: 0.01 - 2.54mm (0.001 - 0.100 inches) PECT: 0.63 - 508mm (0.025 - 19.999 inches) PECT: 0.01 - 2.54mm (0.001 - 0.100 inches)	PE: 0.63 - 508mm (0.025 - 19.999 inches) PETP: 0.63 - 508mm (0.025 - 19.999 inches) EE: 1.27 - 102mm (0.050 - 4.000 inches) EEV: 1.27 - 25.4mm (0.050 - 1.000 inches) CT: 0.01 - 2.54mm (0.001 - 0.100 inches) PECT: 0.63 - 508mm (0.025 - 19.999 inches) PECT: 0.01 - 2.54mm (0.001 - 0.100 inches)	Measuring Range²
±0.01mm (±0.001 inches)	±0.01mm (±0.001 inches)	Measurement Accuracy²
0.01mm (0.001 inches)	0.01mm (0.001 inches)	Measurement Resolution
1250 - 13,995m/s (0.0492 - 0.5510in/ms)	1250 - 9,999m/s (0.0492 - 0.3936in/ms)	Velocity Calibration Range
<ul style="list-style-type: none"> • • • 	<ul style="list-style-type: none"> • • • 	Additional Features:³ High speed scan mode Differential mode Limit alarm mode
adjustable display speed	adjustable display speed	B-Scan display speed
Basic prove-up flaw detection using single element angle beam transducers	Basic prove-up flaw detection using single element angle beam transducers	Flaw Mode
6 factory & 64 user-definable setups transferrable to and from a PC archive	6 factory & 64 user-definable setups transferrable to and from a PC archive	Calibration Setups
3 fully adjustable gates: start, stop, width & threshold	3 fully adjustable gates: start, stop, width & threshold	Gates
	adjustable; impedance matching for optimising transducer performance	Damping
dual 200 volt square wave pulsers with adjustable pulse width (spike, thin, wide) and 50 volt cut/boost for greater penetration	dual 200 volt square wave pulsers with adjustable pulse width (spike, thin, wide) and 50 volt cut/boost for greater penetration	Pulsers Type
manual, automatic gain control (AGC) with 110dB range (limited), or selectable gain: vlow, low, medium hi or vhi	manual, automatic gain control (AGC) with 110dB range (limited), or selectable gain: vlow, low, medium hi or vhi	Gain
precision 25MHz TCXO with single shot 100MHz 8bit ultra low power 8 bit digitizer	precision 25MHz TCXO with single shot 100MHz 8bit ultra low power 8 bit digitizer	Timing

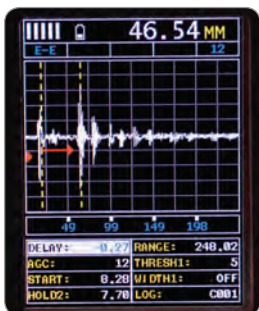

EE

Echo - Echo Mode

Also known as the ThruPaint™ Mode, EE ignores the coating thickness, displaying the material thickness from the top surface of the material to the material density boundary.



EEV

Echo - Echo Verify Mode

The echo-echo verify mode measures by comparing the values between 3 reflections and is commonly used to eliminate errors from surface coatings and to make measurements in multiple layered materials.

¹ PE: Pulse-Echo Mode, PETP: Pulse-Echo Temperature Compensation Mode, EE: Echo-Echo (ThruPaint™) Mode, EEV: Echo-Echo Verify, CT: Coating Thickness Mode, PECT: Pulse-Echo, Coating Thickness Mode; See page 3 for further information

² Measuring range & accuracy depends on material, surface conditions and the transducer selected

³ See page 5 for a full explanation of the features

CG100B, CG100BDL, CG100ABDL & CG100ABDL+

Model & Part Number	CG100B	CG100BDL
Data logging		<ul style="list-style-type: none"> 16,000 with B-scan image & gauge settings 210,000 - coating, material, min, max thickness sequential and grid logging Alpha numeric batch identification OBSTRUCT indicates inaccessible locations
Calibration Options	single, two point, velocity & material type	single, two point, velocity & material type
Transducer Probe Type	dual element	dual element
Transducer Frequency Range	1 - 10MHz	1 - 10MHz
Transducer Recognition	automatic & manual - selectable from a list	automatic & manual - selectable from a list
V-path / dual path error correction	automatic	automatic
Probe Zero	automatic & manual (via integrated probe disk)	automatic & manual (via integrated probe disk)
Display	1/4 VGA (grayscale) 62 x 45.7mm (2.4 x 1.8 inches) viewable area	1/4 VGA (grayscale) 62 x 45.7mm (2.4 x 1.8 inches) viewable area
Display Refresh Rate	25Hz	25Hz
Units (selectable)	mm or inches	mm or inches
Backlight	on / off / auto	on / off / auto
Repeatability / Stability Indicator	●	●
Battery Type	3 x AA alkaline	3 x AA alkaline
Battery Life (approximate)	150 hours	150 hours
Low Battery Indicator	●	●
Battery Save Mode	auto	auto
Operating Temperature	-10 to 60°C (14 to 140°F)	-10 to 60°C (14 to 140°F)
Size (w x h x d)	63.5 x 165.0 x 31.5mm (2.5 x 6.5 x 1.24 inches)	63.5 x 165.0 x 31.5mm (2.5 x 6.5 x 1.24 inches)
Weight (including batteries)	383g (13.5oz)	383g (13.5oz)
Aluminium case design with gasket sealed end caps, waterproof membrane keypad	●	●
Transducer Connector Type	LEMO	LEMO
RS232 Interface	Bi-directional	Bi-directional
Packing List	Elcometer NDT CG100B gauge, couplant, carry case, user manual, test certificate, 3 x AA batteries	Elcometer NDT CG100BDL gauge, couplant, carry case, user manual, test certificate, 3 x AA batteries, software, transfer cable

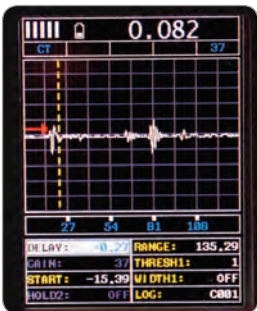

CT
Coating Only Mode
Displays the thickness of the coating applied to the material.



PECT
Pulse - Echo Coating Mode
Displays both the material thickness (PE) and the coating thickness (CT) at the same time.

Specifications (continued)

CG100ABDL	CG100ABDL+	Model & Part Number
<ul style="list-style-type: none"> 16,000 with A/B-scan image & gauge settings 210,000 - coating, material, min, max thickness sequential and grid logging Alpha numeric batch identification OBSTRUCT indicates inaccessible locations 	<ul style="list-style-type: none"> 8,000 with A/B-scan image & gauge settings 210,000 - coating, material, min, max thickness sequential and grid logging Alpha numeric batch identification OBSTRUCT indicates inaccessible locations 	Data logging
single, two point, velocity & material type	single, two point, velocity & material type	Calibration Options
dual element & flaw prove up	dual element & flaw prove up	Transducer Probe Type
1 - 10MHz	1 - 10MHz	Transducer Frequency Range
automatic & manual - selectable from a list	manual - selectable from a list	Transducer Recognition
automatic	automatic	V-path / dual path error correction
automatic & manual (via integrated probe disk)	manual (via integrated probe disk)	Probe Zero
1/4 VGA (grayscale) 62 x 45.7mm (2.4 x 1.8 inches) viewable area	1/4 VGA AMOLED colour display 57.6 x 43.2mm (2.27 x 1.78 inches) viewable area	Display
25Hz	120Hz	Display Refresh Rate
mm or inches	mm or inches	Units (selectable)
on / off / auto	adjustable brightness	Backlight
●	●	Repeatability / Stability Indicator
3 x AA alkaline	3 x AA alkaline	Battery Type
50 hours	25 hours	Battery Life (approximate)
●	●	Low Battery Indicator
auto	auto	Battery Save Mode
-10 to 60°C (14 to 140°F)	-10 to 60°C (14 to 140°F)	Operating Temperature
63.5 x 165.0 x 31.5mm (2.5 x 6.5 x 1.24 inches)	63.5 x 165.0 x 31.5mm (2.5 x 6.5 x 1.24 inches)	Size (w x h x d)
383g (13.5oz)	383g (13.5oz)	Weight (including batteries)
●	●	Aluminium case design with gasket sealed end caps, waterproof membrane keypad
LEMO	LEMO	Transducer Connector Type
Bi-directional	Bi-directional	RS232 Interface
Elcometer NDT CG100ABDL gauge, couplant, carry case, user manual, test certificate, 3 x AA batteries, software, transfer cable	Elcometer NDT CG100ABDL+ gauge, couplant, carry case, user manual, test certificate, 3 x AA batteries, software, transfer cable	Packing List

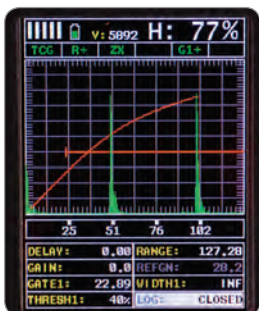

TCG

Time Corrected Gain

Time corrected gain increases gain as distance increases, in order to achieve an over all level of sensitivity for the same flaw/reflector at different distances.

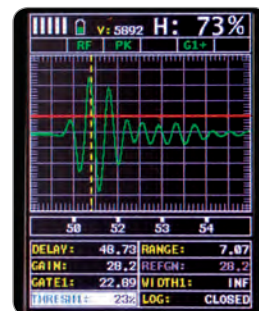

FLAW MODE

Basic Flaw Mode

Basic prove-up flaw detection using single element angle beam transducers is available on the CG100ABDL and CG100ABDL+ corrosion thickness gauges.

¹ PE: Pulse-Echo Mode, PETP: Pulse-Echo Temperature Compensation Mode, EE: Echo-Echo (ThruPaint™) Mode, EEV: Echo-Echo Verify, CT: Coating Thickness Mode, PECT: Pulse-Echo, Coating Thickness Mode; See page 3 for further information

² Measuring range & accuracy depends on material, surface conditions and the transducer selected

³ See page 5 for a full explanation of the features

The UG20DL is an underwater material and coating thickness gauge ideal for offshore inspections.



Waterproof to a depth of 300 metres (1,000 feet) the UG20DL offers many features and benefits of the CG100 series in an easy to use brightly lit gauge.

Offering both dual & single element transducers the UG20DL's memory allows users to store up to 5,000 individual readings, together with the A-Scan waveform which can be downloaded to the data management software for further analysis on dry land.

Advantages

- 300 metre (1000 ft.) depth rating
- Single membrane & dual element probe transducers
- Automatic probe recognition & zero function
- Pulse-Echo, Pulse-Echo w/Coating, Echo-Echo and TCG (time corrected gain)
- Data Storage: Alpha Numeric & Sequential w/ID
- Data output and storage: 5,000 readings and waveforms or B-Scans
- Data management software

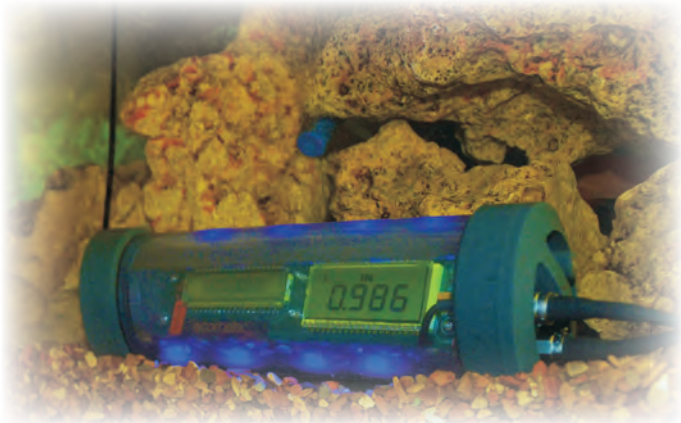

See Page 43
for full range
of Transducers

Model & Part Number	UG20DL
Display Mode: Material thickness digits display	●
Measurement Mode ¹	Dual Element: PE, EE (ThruPaint™), PECT Single Element: Triple-Echo (ThruPaint™)
Measurement Rate: Manual	4 readings per second
Measuring Range ²	PE: 0.63 - 500mm (0.025 - 19.999 inches) EE: 2.54 - 102mm (0.100 - 4.000 inches) PECT: 0.63 - 500mm (0.025 - 19.999 inches) PECT: 0.01 - 2.54mm (0.001 - 0.100 inches) Triple: 1.00 - 150mm (0.040 - 6.000 inches)
Measurement Accuracy ²	±0.01mm (±0.001 inches)
Measurement Resolution	0.01mm (0.001 inches)
Velocity Calibration Range	1250 - 13,995m/s (0.0492 - 0.5510in/ms)
Additional Features: ³ A-Scan	stored in memory with each reading for review on PC
Calibration setups	1 user programmable & 8 pre-calibrated velocities for: aluminium, cast iron, iron, PVC, polyurethane, polystyrene, stainless steel & steel
Waterproof - depth rating	maximum depth 300 metres (1,000 feet) - equivalent to IP68
Pulser Type	dual square wave pulsers
Gain	time corrected gain (TCG), automatic gain control (AGC) with 100dB range, or selectable gain: vlow, low, medium hi or vhi
Timing	precision 25MHz TCXO with single shot 100MHz 8bit ultra low power 8 bit digitizer
Data Logging	<ul style="list-style-type: none"> • 5,000 with A-scan image & gauge settings in one batch • sequential and grid logging • alpha numeric batch identification
Calibration Options	velocity & material type
Transducer Probe Type	dual and single element
Transducer Frequency Range	1 - 10MHz
Transducer Recognition	custom automatic (dual transducers) & manual - selectable from a list
V-path / dual path error correction	automatic
Probe Zero	automatic (dual transducers) & manual (via integrated probe disk)
Display	12.7mm (1/2") 4.5 digit LCD
Display Refresh Rate	25Hz
Units (selectable)	mm or inches
Backlight	on / off / auto
Repeatability / Stability Indicator	●
Battery Type	3 x AA alkaline
Battery Life (approximate)	50 hours (15 hours with backlight on)
Low Battery Indicator	●
Battery Save Mode	auto
Operating Temperature	-29 to 60°C (-20 to 140°F)
Size (length x diameter)	229.0 x 60.33mm (9.0 x 2.4 inches)
Weight (including batteries)	680g (24.0oz)
Case Design	high strength transparent plastic housing with single, magnetically coupled, multifunction switch
Transducer Connector Type	LEMO underwater connectors
RS232 Interface	Bi-directional
Packing List	Elcometer NDT UG20DL gauge, couplant, carry case, user manual, test certificate, 3 x AA batteries, software, transfer cable, spare gaskets and lubrication set

¹ PE: Pulse-Echo Mode, EE: Echo-Echo (ThruPaint™) Mode, PECT: Pulse-Echo Coating Thickness Mode; See page 3 for further information

² Measuring range & accuracy depends on material, surface conditions and the transducer selected

³ See page 5 for a full explanation of the features

SG80 & SG80BDL

Sonic Thickness Gauges

The SG80 Series sonic thickness gauges have been specially designed for the automotive industry.

The SG80 & SG80BDL are frequently used for measuring the thickness of cylinder walls, intake or exhaust ports, chassis, tubing, body panels, and windscreens. It also has the ability to scan the length of a part to find the minimum thickness.

The time-based B-Scan feature of the SG80BDL displays a cross section of the opposite surface, allowing engine builders the ability to see the contour of the back surface in cylinders while scanning.

Use the Echo-Echo ThruPaint™ feature of the SG80BDL to measure chassis tubing with or without paint and other coatings.



Advantages

- Range of display & measurement options: Pulse-Echo, Echo-Echo ThruPaint™ technology
- Multiple calibration and material selection options
- Adjustable gain: -30dB to 70dB range
- Automatic gain control (AGC)
- 64 User definable setups
- High speed scan: 32 readings per second
- Differential and minimal thickness alarm modes
- Data output and storage: 12,000 readings and waveforms or B-Scans
- Data management software



See Page 45
for full range
of Transducers

Model & Part Number	SG80	SG80BDL
Display Mode: Material thickness digits display	●	●
Measurement Mode¹	PE & EE (ThruPaint™)	PE & EE (ThruPaint™)
Measurement Rate: Manual: Scan Mode:	4 readings per second 16 readings per second	4 readings per second 32 readings per second
Measuring Range²	0.63 - 500mm (0.025 - 19.999 inches)	PE 0.63 - 254mm (0.025 - 9.999 inches) EE 1.27 - 102 mm (0.050 - 4 inches)
Measurement Accuracy²	±0.01mm (±0.001 inches)	±0.01mm (±0.001 inches)
Measurement Resolution	0.01mm (0.001 inches)	0.01mm (0.001 inches)
Velocity Calibration Range	1250 - 10,000m/s 0.0492 - 0.3937in/μs	1250 - 10,000m/s 0.0492 - 0.3937in/μs
Additional Features:³ High speed scan mode Limit alarm mode	●	● ●
Data Logging		12,000 readings (+ B Scans)
Calibration Options	1 & 2 point	1 & 2 point, velocity and material selection
Transducer Probe Type	dual element	dual element
Transducer Frequency Range	1 - 10MHz	1 - 10MHz
V-path / dual path error correction	automatic	automatic
Display	LCD with 12.7mm (0.5 inches) high digits	1/8 VGA
Units (selectable)	mm or inches ; m/s or in/μs	mm or inches
LED Backlight	on / off / auto	on / off / auto
Repeatability / Stability Indicator	●	●
Battery Type	2 x AA alkaline	3 x AA alkaline
Battery Life (approximate)	200 hours	150 hours
Low Battery Indicator	●	●
Battery Save Mode	auto	auto
Operating Temperature	-30 to 50°C (-20 to 120°F)	-10 to 60°C (14 to 140°F)
Size (w x h x d)	63.5 x 114.3 x 31.5mm 2.5 x 4.5 x 1.24 inches	63.5 x 165 x 31.5mm 2.5 x 6.5 x 1.24 inches
Weight (including batteries)	284g (10oz)	383g (13oz)
Aluminium case design with gasket sealed end caps, waterproof membrane keypad	●	●
Transducer Connector Type	LEMO	LEMO
RS232 Interface		●
Packing List	Elcometer NDT SG80 gauge, couplant, carry case, user manual, test certificate, 2 x AA batteries	Elcometer NDT SG80BDL gauge, couplant, carry case, user manual, test certificate, 3 x AA batteries, software, transfer cable

¹ PE: Pulse-Echo Mode, EE: Echo-Echo (ThruPaint™) Mode; See page 3 for further information

² Measuring range & accuracy depends on material, surface conditions and the transducer selected

³ See page 5 for a full explanation of the features

Custom transducers available for special applications

When pinpoint accuracy is the key, the variety of features offered in the PG70 and PG70DL allow users to measure with precision.

The PG70 series have ThruPaint™ technology allowing you to accurately measure the thickness of thin substrates.

The gauges are typically used for thin material applications. This gauge has the ability to calibrate to a variety of different materials using the one point calibration option.

Some of the features include: High speed scan mode (allowing the user to scan an area for the minimum thickness), limit alarm mode enabling users to set the allowable thickness limits and differential mode which displays the thickness variation (+/-) to a user defined nominal thickness.



Advantages

- 0.001mm high resolution
- Differential mode
- Minimal thickness alarm
- Internal data-logging
- Data output and storage
- Interface to Echo, Echo-to-Echo (ThruPaint™) and Auto-Switchable
- Four readings per second for single point measurements or 8 per second in Scan Mode captures the minimum thickness
- Single point calibration



See Page 44
for full range
of Transducers

Model & Part Number	PG70	PG70DL
Display Mode: Material thickness digits display	●	●
Measurement Mode¹	IE & EE (ThruPaint™)	IE & EE (ThruPaint™)
Measurement Rate: Manual: Scan Mode:	4 readings per second 8 readings per second	4 readings per second 8 readings per second
Measuring Range²	0.15 - 25.40mm (0.0060 - 1.0000 inches)	0.15 - 25.40mm (0.0060 - 1.0000 inches)
Measurement Accuracy²	±0.002mm (±0.0008 inches)	±0.002mm (±0.0008 inches)
Measurement Resolution	0.001mm (0.0001 inch)	0.001mm (0.0001 inch)
Velocity Calibration Range	1250 - 10,000m/s 0.0492 - 0.3937in/μs	1250 - 10,000m/s 0.0492 - 0.3937in/μs
Additional Features:³ High speed scan mode Differential mode Limit alarm mode	● ● ●	● ● ●
Data Logging		1,000 readings (10 batches of 100 readings)
Calibration Options	single & velocity	single & velocity
Transducer Probe Type	single element with delay tip	single element with delay tip
Transducer Frequency Range	1 - 20MHz	1 - 20MHz
V-path / dual path error correction	automatic	automatic
Display	LCD with 12.7mm (0.5 inches) high digits	LCD with 12.7mm (0.5 inches) high digits
Units (selectable)	mm or inches	mm or inches
LED Backlight	on / off / auto	on / off / auto
Repeatability / Stability Indicator	●	●
Battery Type	2 x AA alkaline	2 x AA alkaline
Battery Life (approximate)	150 hours	150 hours
Low Battery Indicator	●	●
Battery Save Mode	auto	auto
Operating Temperature	-30 to 50°C (-20 to 120°F)	-30 to 50°C (-20 to 120°F)
Size (w x h x d)	63.5 x 114.3 x 31.5mm 2.5 x 4.5 x 1.24 inches	63.5 x 114.3 x 31.5mm 2.5 x 4.5 x 1.24 inches
Weight (including batteries)	284g (10oz)	284g (10oz)
Aluminium case design with gasket sealed end caps, waterproof membrane keypad	●	●
Transducer Connector Type	LEMO	LEMO
RS232 Interface	●	●
Packing List	Elcometer NDT PG70 gauge, couplant, carry case, user manual, test certificate, 2 x AA batteries	Elcometer NDT PG70DL gauge, couplant, carry case, user manual, test certificate, 2 x AA batteries, software, transfer cable

¹ PE: Pulse-Echo Mode, EE: Echo-Echo (ThruPaint™) Mode; See page 3 for further information

² Measuring range & accuracy depends on material, surface conditions and the transducer selected

³ See page 5 for a full explanation of the features

PG70ABDL offers inspectors a graphical representation of the material's thickness with greater precision.

With a user selectable resolution of either 0.01mm or 0.001mm (0.001/0.0001 inch) the PG70ABDL can display the thickness value together with A and B-Scan displays, providing users with the ability to accurately assess a wide range of materials.

The auto find feature locates the detection point(s) and adjusts the display settings to bring the waveform into view.

The high speed scan feature speeds up the inspection process by taking 32 measurements per second. Remove the transducer from the test material and display the minimum measurement scanned.

Visual and audible alarm with high and low limit settings for specific application tolerances.



Advantages

- 0.001mm high resolution
- Range of display options: A-Scan, B-Scan, Pulse-Echo, Echo-Echo
- Adjustable gain: -30dB to 70dB range
- Automatic gain control (AGC)
- User definable setups
- Multiple language display
- Multiple calibration and material selection options
- High speed scan: 32 readings per second
- Differential mode
- Minimal thickness alarm
- Data output and storage: 12,000 readings and waveforms
- Data management software



See Page 44
for full range
of Transducers

Model & Part Number	PG70ABDL
Display Mode: Material thickness digits display B-Scan cross sectional display Combined B-Scan and digits display Scan bar display A-Scan display	● ● ● ● + Rectified, - Rectified, Full Waveform (RF)
Measurement Mode ¹	PE, IE, Plastic & EE (ThruPaint™)
Measurement Rate: Manual Scan mode Scan bar display	4 readings per second 32 readings per second 6 readings per second
Measuring Range ²	PE (contact) on steel: 1.000 - 254mm (0.040 - 10.000 inches) PE (contact) on plastic: from 0.254mm (0.010 inches) IE on steel: 1.27 - 25.4mm (0.050 - 1.000 inches) IE on plastic: from 0.127mm (0.005 inches) EE (contact) on steel: 2.54 - 76.20mm (0.100 - 3.000 inches) - ThruPaint™ EE on steel: 0.15 - 12.70mm (0.006 - 0.500 inches)
Measurement Accuracy ²	±0.001mm (±0.0001 inches)
Measurement Resolution	user selectable: 0.01mm / 0.001mm (0.001 / 0.0001 inches)
Velocity Calibration Range	1250 - 9,999m/s (0.0492 - 0.3936in/ms)
Additional Features: ³ High speed scan mode Differential mode Limit alarm mode Selectable resolution	● ● ● ●
B-Scan display speed	15 seconds per screen
Calibration setups	16 factory & 48 user-definable setups transferrable to and from a PC archive
Gates	<ul style="list-style-type: none"> • PE: 1 gate; IE, Plastic & EE: 1 gate with hold off • Adjustable threshold
Pulser Type	square wave pulser with adjustable pulse width (spike, thin, wide)
Gain	manual or automatic gain control (AGC) with 40dB range (depending on mode selected)
Timing	40MHz with ultra low power 8 bit digitizer
Data Logging	<ul style="list-style-type: none"> • 12,000 readings with waveforms • grid logging • Alpha Numeric batch identification • OBSTRUCT indicates inaccessible locations
Calibration Options	single, two point, velocity & material type
Transducer Probe Type	single element with delay tip, pencil with delay tip & contact probes
Transducer Frequency Range	1 - 20MHz
Transducer Recognition	manual - selectable from a list
V-path / dual path error correction	automatic
Probe Zero	manual (via integrated probe disk)
Display	1/8 VGA (grayscale), 62 x 45.7mm (2.4 x 1.8 inches) viewable area
Units (selectable)	mm or inches
LED Backlight	on / off / auto
Repeatability / Stability Indicator	●
Battery Type	3 x AA alkaline
Battery Life (approximate)	150 hours
Low Battery Indicator	●
Battery Save Mode	auto
Operating Temperature	-10 to 60°C (14 to 140°F)
Size (w x h x d)	63.5 x 165.0 x 31.5mm (2.5 x 6.5 x 1.24 inches)
Weight (including batteries)	383g (13.5oz)
Aluminium case design with gasket sealed end caps, waterproof membrane keypad	●
Transducer Connector Type	LEMO
RS232 Interface	Bi-directional
Packing List	Elcometer NDT PG70ABDL gauge, couplant, carry case, user manual, test certificate, 3 x AA batteries, software, transfer cable

¹ PE: Pulse-Echo Mode, EE: Echo-Echo (ThruPaint™) Mode, IE: Interface - Echo Mode; See page 3 for further information

² Measuring range & accuracy depends on material, surface conditions and the transducer selected

³ See page 5 for a full explanation of the features

FD700+ & FD700DL+

These small powerful hand-held flaw detectors combine state-of-the-art flaw detection with advanced material thickness capabilities.

With all the functionality of the top of the range material thickness gauge, the FD700+ series, when in flaw detection mode offers a variety of tool kits which enable fast and accurate flaw detection, ideal for weld inspection, forgings or composite material testing.

Tool kits include:

- TRIG enabling location of flaws in both surface distance and depth.
- DAC for the creation of DAC curves which are used to inform the operator of the size of any given flaw at any depth.
- AWS function provides automatic defect sizing in accordance with AWS D1.1 structural welding code.
- AVG/DGS allows automatic defect sizing using probe data, storing up to 64 custom setups.
- TCG (time corrected gain) increases gain as distance increases, in order to achieve an over all level of sensitivity for the same flaw/reflector at different distances.



See Page 48
for full range
of Transducers

Flaw Detection Gauges



Advantages

- Exceptional visibility in sunlight (AMOLED) colour VGA display (320x240 pixels)
- Sizing Toolkits: DAC, AWS, TCG, DGS
- P.R.F. - 8 to 333 Hz, adjustable
- Screen Refresh Rate: Adjustable 60 & 120 Hz
- Detection: Z-Cross, Flank & Peak
- Automatic: probe zero, probe recognition, and temperature compensation
- Measurement: Variety of modes to address a number of applications
- Large data storage with multiple formats: Alpha numeric grid and sequential w/auto identifier
- Up to 12 hours of battery life
- Data management software

FD700+ & FD700DL+

TRIG

TRIG enabling location of flaws in both surface distance and depth. Trigonometric display of beam path, depth, surface distance, and curved surface correction. Used with angle beam transducers.

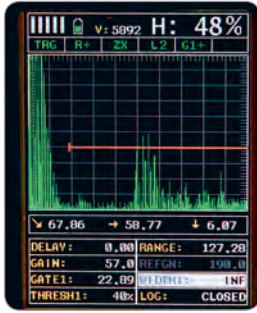

DAC

Distance amplitude correction for the creation of DAC curves which are used to inform the operator of the size of any given flaw at any depth.

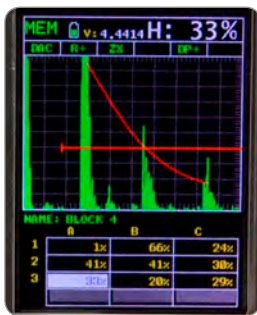

AWS

The American Weld Standard function provides automatic defect sizing in accordance with AWS D1.1 structural welding code.

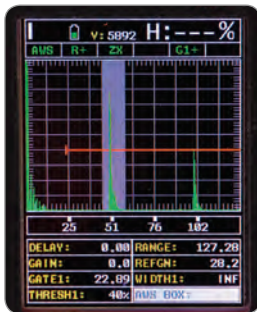

TCG

Time corrected gain increases gain as distance increases, in order to achieve an over all level of sensitivity for the same flaw/reflector at different distances.

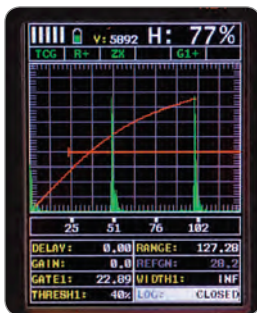

Material Thickness Features

Model & Part Number	FD700+ & FD700DL+
Display Mode: Material thickness digits display B-Scan cross sectional display B-Scan with digits display Scan bar display Coating thickness display A-Scan display Flaw detection modes	<ul style="list-style-type: none"> • • • • • + Rectified, - Rectified, Full Waveform (RF) TRIG, DAC, AWS, TCG, Zero Crossing, Flank, Peak
Measurement Mode¹	PE, PETP (Temp Compensation), EE (ThruPaint™), EEV, CT (Coating) & PECT
Measurement Rate (Thickness Mode) Manual: Scan mode Scan bar display	4 readings per second 32 readings per second 6 readings per second
Measuring Range²	PE: 0.63 - 30480mm (0.025 - 12,000 inches) PETP: 0.63 - 30480mm (0.025 - 12,000 inches) EE: 1.27 - 102mm (0.050 - 4.000 inches) EEV: 1.27 - 25.4mm (0.050 - 1.000 inches) CT: 0.01 - 2.54mm (0.0005 - 0.100 inches) PECT: 0.63 - 30480mm (0.025 - 12,000 inches) PECT: 0.01 - 2.54mm (0.0005 - 0.100 inches)
Measurement Accuracy²	±0.01mm (±0.001 inches)
Measurement Resolution	0.01mm (0.001 inches)
Velocity Calibration Range	256 - 16,000m/s (0.0100 - 0.6300in/ms)
Additional Features:³ High speed scan mode Differential mode Limit alarm mode	<ul style="list-style-type: none"> • • •
B-Scan display speed	adjustable display speed
Calibration Setups	6 factory & 64 user-definable setups transferable to and from a PC archive
Gates	3 fully adjustable gates: start, stop, width & threshold
Damping	adjustable; impedance matching for optimising transducer performance
Pulsar Type	dual 200 volt square wave pulsers with adjustable pulse width (spike, thin, wide) and 50 volt cut/boost for greater penetration
Gain	manual, automatic gain control (AGC) with 110dB range with 0.2dB resolution
Timing	precision 25MHz TCXO with single shot 100MHz 8bit ultra low power 8 bit digitizer
Data Logging	<ul style="list-style-type: none"> • 8,000 with A/B-scan image & gauge settings • 210,000 - coating, material, min, max thickness • sequential and grid logging • Alpha numeric batch identification • OBSTRUCT indicates inaccessible locations
Calibration Options	single, two point, velocity & material type
Transducer Recognition	automatic
V-path / dual path error correction	automatic
Probe Zero	automatic

¹ PE: Pulse-Echo Mode, EE: Echo-Echo (ThruPaint™) Mode;
See page 3 for further information

² Measuring range & accuracy depends on material, surface conditions and
the transducer selected

³ See page 5 for a full explanation of the features

Specifications

Flaw Detection Features

Flaw Detection Mode Features	
Automatic Calibration:	Longitudinal (straight), or Shear (angle)
Probe Types:	Single Contact, Dual, Delay & Angle
Material Velocity Table:	Contains longitudinal and shear velocities for a variety of material types
TRIG	Trigonometric display of beam path, depth, surface distance, and curved surface correction. Used with angle beam transducers
DAC	Up to 8 points may be entered and used to digitally draw a DAC curve. Reference -2, -6, -10, (-6/-12), (-6/-14), (-2/-6/-10) dB. Amplitude displayed in %DAC, dB, or %FSH
AWS	Automatic defect sizing in accordance with AWS D1.1 structural welding code.
AVG/DGS	Automatic defect sizing using probe data. Stores up to 64 custom setups
TCG	Time corrected gain. 50 dB dynamic range, 20 dB per microsecond, up to 8 points for curve definition
Detection Modes	Zero Crossing, Flank and Peak
Display Freeze	Hold current waveform on screen
Peak Memory	Captures peak signal amplitude.
P.R.F	8 to 333Hz in selectable steps (8, 16, 32, 66, 125, 250, 333Hz)
Pulse Width	40 to 400 ns. Selectable step options 40, 80 & 400 ns (labeled spike, thin & wide)
Frequency Bands	FD700+ & FD700DL+: Broadband 1.8 - 19 MHz (-3dB). FD700DL+: Three narrow bands at 2MHz, 5MHz, 10MHz
Horizontal Linearity	+/- 0.4% FSW
Vertical Linearity	+/- 1% FSH
Amplifier Linearity	+/- 1 dB
Amplitude Measurement	0 to 100% FSH, with 1% resolution
Delay	0 - 999in (25,375mm) at steel velocity
Display	1/4 VGA AMOLED colour display 57.6 x 43.2mm (2.27 x 1.78inches) viewable area
Display Refresh Rate	120Hz
Units (selectable)	mm or inches
Backlight	adjustable brightness
Repeatability / Stability Indicator	●
Battery Type	3 x AA alkaline
Battery Life (approximate)	12 hours
Low Battery Indicator	●
Battery Save Mode	auto
Operating Temperature	-10 to 60°C (14 to 140°F)
Size (w x h x d)	63.5 x 165.0 x 31.5mm (2.5 x 6.5 x 1.24 inches)
Weight (including batteries)	397g (14oz)
Case Design	Aluminium case design with gasket sealed end caps, waterproof membrane keypad
Transducer Connector Type	LEMO
RS232 Interface	Bi-directional
Packing List	Elcometer NDT FD700+ or FD700DL+ gauge, couplant, carry case, user manual, test certificate, 3 x AA batteries, software, transfer cable

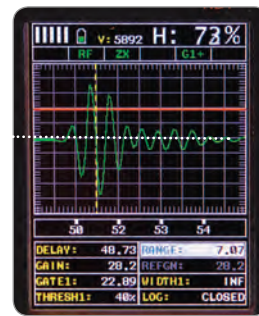

Zero Crossing

The gate detects the flank of the pulse, but the measurement is taken at the next crossing of the x axis. This is the most common type of detect in ultrasonic measurement.

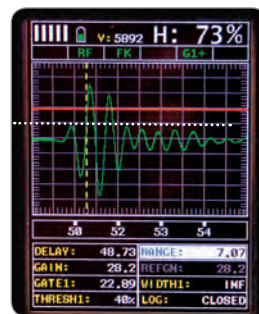

Flank

The gate is triggered by the flank (or side) of the pulse on the graph and the measurement taken at this exact point.

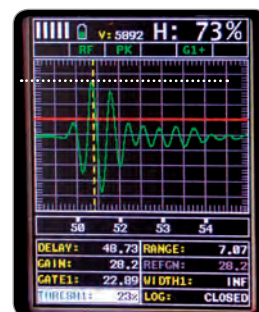

Peak

The gate is triggered by the intersection with the A-scan pulse and the detection is taken from the next peak in the signal (when it stops rising and starts falling).

BG80DL & BG80TDL

Bolt Tension Monitor

Ultrasonically measures the elongation, load, stress & %strain of a bolt under load.

When nuts and bolts are fastened together under load the action of tightening the nut increases the force applied to the bolt causing elongation.

The BG80 Series of bolt tension monitors accurately measure this elongation allowing the gauges to accurately measure time (nanoseconds), elongation, load, stress, and %strain of the bolt.

By using ultrasonics, bolt tension monitors are not affected by temperature, friction or resistance factors affecting the accuracy of standard torque measurement techniques - giving the BG80 Series accuracy within 0.0001mm (0.00001 inch).

Using the gauge's RS232 interface together with the optional shut off accessory the gauge can be programmed to automatically stop the tightening process when the appropriate load has been applied.

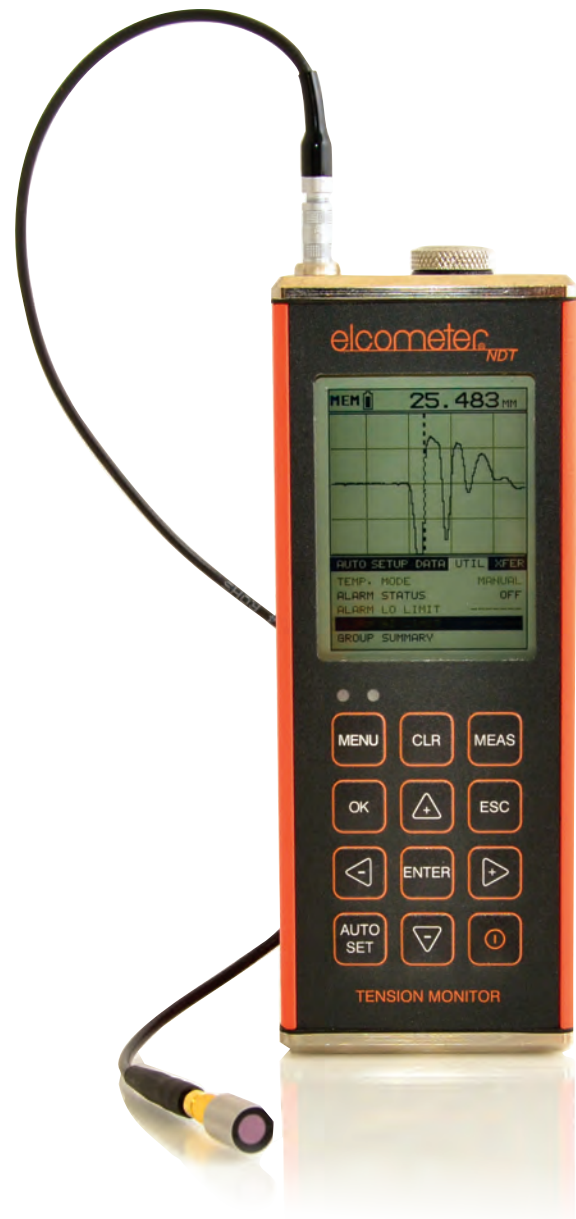

Advantages

- Range of display & measurement options including Elongation, Load, Stress, and %Strain, RF, Rectified, Large Digits with Limits Bar
- BG80TDL features temperature compensation to counteract measurement irregularity caused by temperature change
- Data output and storage: 8,000 readings and waveforms
- Auto Set feature automatically optimizes detection and adjusts display
- Hi/Lo Alarm tolerance limits work in conjunction with the data port



See Page 68
for full range
of Transducers

Model & Part Number	BG80DL	BG80TDL
Display Mode: Material thickness digits display	●	●
Measurement Mode ¹	PE & PE with Gate	PE & PE with Gate
Measurement Rate: Manual: Scan Mode:	4 readings per second 8 readings per second	4 readings per second 8 readings per second
Measuring Range ²	254 - 1370mm (1 - 48 inches)	254 - 1370mm (1 - 48 inches)
Measurement Accuracy ²	±0.0001mm (±0.00001 inches)	±0.0001mm (±0.00001 inches)
Measurement Resolution	0.0001mm (0.00001 inches)	0.0001mm (0.00001 inches)
Velocity Calibration Range	1250 - 10,000m/s 0.0492 - 0.3937in/μs	1250 - 10,000m/s 0.0492 - 0.3937in/μs
Limit Alarm Mode	●	●
Data logging		8,000 readings
Calibration Options	fixed, single & 2 point	fixed, single & 2 point
Transducer Probe Type	single element	single element
Transducer Frequency Range	1 - 10MHz	1 - 10MHz
V-path / dual path error correction	automatic	automatic
Display	1/8 VGA	1/8 VGA
Units (selectable)	mm or inches	mm or inches
LED Backlight	on / off / auto	on / off / auto
Repeatability / Stability Indicator	●	●
Battery Type	3 x AA alkaline	3 x AA alkaline
Battery Life (approximate)	150 hours	150 hours
Low Battery Indicator	●	●
Battery Save Mode	auto	auto
Operating Temperature	-10 to 60°C (14 to 140°F)	-10 to 60°C (14 to 140°F)
Size (w x h x d)	63.5 x 165 x 31.5mm 2.5 x 6.5 x 1.24 inches	63.5 x 165 x 31.5mm 2.5 x 6.5 x 1.24 inches
Weight (including batteries)	383g (13.5oz)	383g (13.5oz)
Aluminium case design with gasket sealed end caps, waterproof membrane keypad	●	●
Transducer Connector Type	LEMO	LEMO
RS232 Interface	●	●
Packing List	Elcometer NDT BG80DL gauge, couplant, carry case, user manual, test certificate, 3 x AA batteries, software, RS232/DB9 & USB/DB9 transfer cable	Elcometer NDT BG80TDL gauge, couplant, carry case, user manual, test certificate, 3 x AA batteries, software, RS232/DB9 & USB/DB9 transfer cable

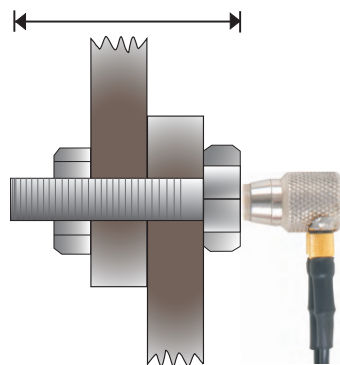

How does it work?

As a fastener is tightened it stretches (elongates) in length.

Manual torque wrenches measure the force applied when tightening a fastener, the accuracy can be affected by temperature, friction and resistance.

As BG80 & BG80TDL ultrasonically measures the change in length accurately determining the applied load of a fastener as it is tightened, they are not affected by these factors.

¹ PE: Pulse-Echo Mode, see page 3 for further information

² Measuring range & accuracy depends on material, surface conditions and the transducer selected

Transducers

Elcometer NDT offer over 450 single and dual transducer probes for material thickness and flaw detection inspection.

Available in a number of measurement frequencies, diameters and connection types to meet almost all applications, the Elcometer NDT range of transducers are also available for measurements on high temperature materials up to 480°C (900°F).



Selecting the **right transducer**

Selecting the right transducer for your application is essential to maximise performance.

Choosing the right **frequency/diameter** combination

Different materials have different acoustic properties. In some a sound wave can travel easily, in others it's absorbed so achieving an accurate measurement can be difficult. To overcome this it is essential to choose the right frequency and diameter for your material.

Low frequency transducers are designed for materials that absorb sound like plastics or composites. The pulse penetrates deeply into the material ensuring a strong return echo and therefore a measurement. This high penetration also means that they are suitable for high material thicknesses.

High frequency transducers are ideal for precision measurement because the pulse they emit is highly focused, reducing the risk of return echoes outside of the measurement area. The high frequency and shorter wavelength also lends itself to measuring thin materials.

Larger diameter probes feature larger crystals which transmit and receive the sound wave. A large crystal transmitter will produce a larger sound wave and a larger receiving crystal will be more sensitive.

As a result, larger transducers tend to have better penetration characteristics than the smaller types.

If this extended range is not required, the smaller transducers can be placed more precisely and in hard to reach areas such as narrow grooves in a material.



Characteristics explained

Potted



Microdot



Lemo 00



What **connection** should it have?

Potted: The transducer is strongly secured to the cable at the factory.

Microdot: The transducer is attached using two small screw type connectors, enabling replacement of the cable in case of accidental damage or wear.

LEMO 00: Large diameter transducers may be purchased with the sturdy Lemo 00 connection on the probe side for increased wear resistance.

What **materials** will they work on?

Elcometer have a wide range of transducers which are suitable for an equally wide range of applications.

Materials will typically have an optimum frequency which will give the strongest signal through a material, although often a single probe can be suitable for a range of applications.

Many materials can be measured ultrasonically; however some can present problems and are unsuitable for this measurement method. Materials such as concrete which is a mixture of different material sizes and types, laminated materials and highly sound absorbing materials such as rubber can be problematic. For more information contact Elcometer.

Frequency & Diameter Disks

Each transducer can be easily identified by the disk on the top.

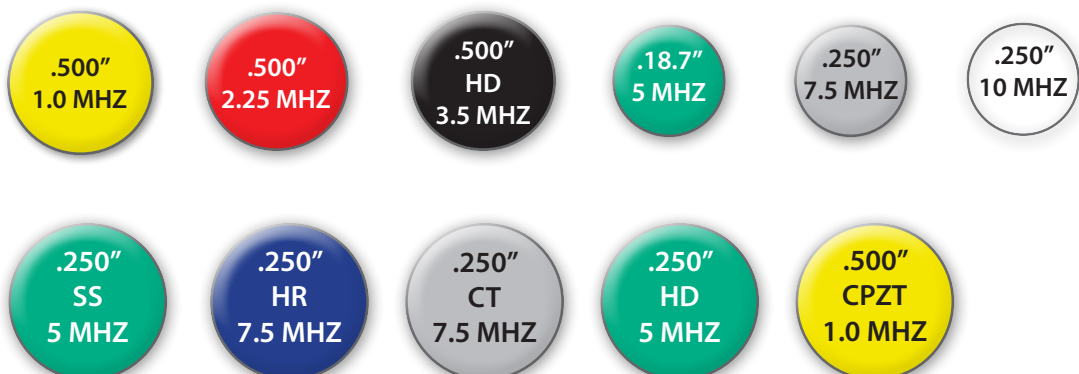

Transducers

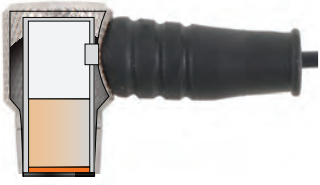

◀ **Single Element**
A single element transducer features a single crystal that sends and receives the pulse and are made for high frequency use.



◀ **Armoured**
Fitted with a heavy duty armoured cable for increased wear resistance.

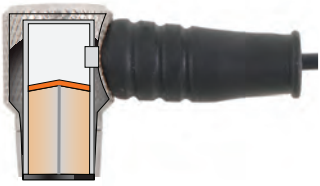

◀ **Dual Element**
A dual element transducer consists of two crystal elements housed in the same case, separated by an acoustic barrier.



◀ **Pencil Probe: 1/16" Tip**
Pencil style transducer with a straight or 90° angle tip for limited access applications.



◀ **High Wear**
Designed for use with the FD700+ flaw detectors features a reinforced tip design for abrasive surface applications. Also available with a high power composite crystal for better penetration.



◀ **Hi Temp**
A high temperature transducer to be used on hot surfaces. High temperature transducers are available up to either 343°C (650°F) or 482°C (900°F).



◀ **Underwater**
Specially designed for use with the UG20DL underwater gauge.



◀ **Delay Line**
Small part used with single element transducers to slow the sound pulse down to allow measurement on thinner materials.



◀ **Finger Tip**
General purpose contact transducers for use with the FD700+ series, featuring good near surface resolution. Also available with a high power composite crystal for better penetration or as a slim line model for accurate positioning.

Characteristics explained



◀ Cylinder Probes

Transducers featuring a curved wearface for measuring inside cylinders and engine blocks. Available for measuring on Iron (Iron) or Aluminium (Alum).



◀ Super Standard

High power transducer for increased range and penetration through sound absorbing materials.



◀ Low Profile

Small body transducer to enable measurement in small spaces, available with either a standard probe or 25mm (1") or 225mm (9") handles.



◀ Damping

Limiting the duration or decreasing the amplitude of vibrations.



◀ Shear Wave

Large Single element transducer designed to be used with angle beam wedges for a powerful flaw detection solution.



◀ Composite

High gain transducer for increased power and penetration.



◀ Membrane

Transducer with a soft, flexible wearface that increases contact quality between the transducer and the part on rough surfaces. Also available with a high power composite crystal for better penetration.



◀ Extra Resolution

Features increased near surface resolution, ideal for use on thin substrates.



◀ Coating Thickness

Utilising ThruPaint™ technology these transducers are capable of simultaneous measurement of coating and material thickness.

Thickness Gauge Transducers

Elcometer NDT offer a complete range of dual element thickness transducers for use with the corrosion, velocity and flaw detection gauge ranges.



Dual Element Thickness Transducers

Dual element transducer for a wide variety of precision thickness measurement applications.



Part Number	Probe Diameter	Probe Characteristic	Damping ¹	ThruPaint™	Connector Type					Suitable for measuring							Suitable for													
					Potted	Microdot	Lemo	Top	Side	End	Cast Iron	Plastics	Thin Plastics	Fibreglass	Thin Fibreglass	Steel	Glass	Aluminium	Titanium	VG10	CG10	CG20	CG30	CG50	CG60	CG70	CG100	FD700+		
1.00 MHz Dual Element Thickness Transducer																														
TX1M00EP-1	1/2"	Standard	S	•			•			•	•		•							•	•	•	•	•	•	•	•	•	•	•
TX1M00EP-2	1/2"	Standard	S	•				•		•	•		•							•	•	•	•	•	•	•	•	•	•	•
TX1M00EM-1	1/2"	Standard	S		•		•			•	•		•							•	•	•	•	•	•	•	•	•	•	•
TX1M00EM-2	1/2"	Standard	S		•			•		•	•		•							•	•	•	•	•	•	•	•	•	•	•
TX1M00EP-3	1/2"	Composite	S	•				•		•	•		•							•	•	•	•	•	•	•	•	•	•	•
TX1M00EL	1/2"	Armoured	S			•		•		•	•		•							•	•	•	•	•	•	•	•	•	•	•
2.25 MHz Dual Element Thickness Transducer																														
TX2M25CP-1	1/4"	Standard	S	•			•			•	•		•							•	•	•	•	•	•	•	•	•	•	•
TX2M25CP-2	1/4"	Standard	S	•				•		•	•		•							•	•	•	•	•	•	•	•	•	•	•
TX2M25CM-1	1/4"	Standard	S		•		•			•	•		•							•	•	•	•	•	•	•	•	•	•	•
TX2M25CM-2	1/4"	Standard	S		•			•		•	•		•							•	•	•	•	•	•	•	•	•	•	•
TX2M25CP-3	1/4"	Hi Temp ²	S	•				•		•	•		•							•	•	•	•	•	•	•	•	•	•	•
TX2M25CM-3	1/4"	Hi Temp ²	S		•		•			•	•		•							•	•	•	•	•	•	•	•	•	•	•
TX2M25EP-1	1/2"	Standard	S	•			•			•	•		•							•	•	•	•	•	•	•	•	•	•	•
TX2M25EP-2	1/2"	Standard	S	•				•		•	•		•							•	•	•	•	•	•	•	•	•	•	•
TX2M25EM-1	1/2"	Standard	S		•		•			•	•		•							•	•	•	•	•	•	•	•	•	•	•
TX2M25EM-2	1/2"	Standard	S		•			•		•	•		•							•	•	•	•	•	•	•	•	•	•	•
TX2M25EP-3	1/2"	Hi Temp ²	S	•				•		•	•		•							•	•	•	•	•	•	•	•	•	•	•
TX2M25EM-3	1/2"	Hi Temp ²	S		•		•			•	•		•							•	•	•	•	•	•	•	•	•	•	•
TX2M25EP-4	1/2"	Composite	S	•				•		•	•		•							•	•	•	•	•	•	•	•	•	•	•
TX2M25EL-1	1/2"	Armoured	S			•		•		•	•		•							•	•	•	•	•	•	•	•	•	•	•
3.50 MHz Dual Element Thickness Transducer																														
TX3M50EP-4	1/2"	Standard	H	•	•			•		•	•		•							•	•	•	•	•	•	•	•	•	•	•
TX3M50EP-1	1/2"	Coating Thickness	CT	•	•			•		•	•		•							•	•	•	•	•	•	•	•	•	•	•
TX3M50EL	1/2"	Armoured	S			•		•		•	•		•							•	•	•	•	•	•	•	•	•	•	•

1. Damping
 S - Standard Undamped Transducer
 H - Highly Damped Transducer
 R - Resolution Transducer

CT - Damped Coating Thickness Transducer
 M - Medium Damped Transducer
 HG - High Gain Damping Transducers
 HR - High Resolution Transducer

2. High temperature probes suitable for measuring 343°C (650°F)
 3. High temperature probes suitable for measuring 482°C (900°F)

Specifications

Dual Element Thickness Transducers - Continued

Dual element transducer for a wide variety of precision thickness measurement applications.



Part Number	Probe Diameter	Probe Characteristic	Damping ¹	ThruPaint™	Connector Type						Suitable for measuring						Suitable for													
					Potted	Microdot	Lemo	Top	Side	End	Cast Iron	Plastics	Thin Plastics	Fibreglass	Thin Fibreglass	Steel	Glass	Aluminium	Titanium	VG10	CG10	CG20	CG30	CG50	CG60	CG70	CG100	FD700+		
5.00 MHz Dual Element Thickness Transducer																														
TX5M00BP-2	3/16"	Standard	S		•			•						•				•	•			•	•	•	•	•	•	•	•	•
TX5M00BP-3	3/16"	Standard	S		•				•					•				•	•			•	•	•	•	•	•	•	•	•
TX5M00BP-5	3/16"	Standard	H	•	•				•					•				•	•			•	•	•	•	•	•	•	•	•
TX5M00BM	3/16"	Standard	S			•			•					•				•	•			•	•	•	•	•	•	•	•	•
TX5M00BP-1	3/16"	Low Profile	S		•				•					•				•	•			•	•	•	•	•	•	•	•	•
TX5M00BP-4	3/16"	Coating Thickness	CT	•	•				•					•				•	•			•	•	•	•	•	•	•	•	•
TX5M00CP-3	1/4"	Standard	S		•			•						•				•	•			•	•	•	•	•	•	•	•	•
TX5M00CP-9	1/4"	Standard	H	•	•			•						•				•	•			•	•	•	•	•	•	•	•	•
TX5M00CP-4	1/4"	Standard	S		•				•					•				•	•			•	•	•	•	•	•	•	•	•
TX5M00CP-10	1/4"	Standard	H	•	•			•						•				•	•			•	•	•	•	•	•	•	•	•
TX5M00CM-1	1/4"	Standard	S			•		•						•				•	•			•	•	•	•	•	•	•	•	•
TX5M00CM-2	1/4"	Standard	S			•			•					•				•	•			•	•	•	•	•	•	•	•	•
TX5M00CM-9	1/4"	Standard	H	•		•			•					•				•	•			•	•	•	•	•	•	•	•	•
TX5M00CP-1	1/4"	Low Profile 1" Wand	S		•				•					•				•	•			•	•	•	•	•	•	•	•	•
TX5M00CP-2	1/4"	Low Profile 9" Wand	S		•				•					•				•	•			•	•	•	•	•	•	•	•	•
TX5M00CP-5	1/4"	Super Standard	S		•				•					•				•	•			•	•	•	•	•	•	•	•	•
TX5M00CP-6	1/4"	Coating Thickness	CT	•	•				•					•				•	•			•	•	•	•	•	•	•	•	•
TX5M00CM-3	1/4"	Coating Thickness	CT	•		•			•					•				•	•			•	•	•	•	•	•	•	•	•
TX5M00CP-7	1/4"	Hi Temp ²	S		•			•						•				•	•			•	•	•	•	•	•	•	•	•
TX5M00CP-8	1/4"	Hi Temp ²	H	•	•			•						•				•	•			•	•	•	•	•	•	•	•	•
TX5M00CM-4	1/4"	Hi Temp ³	H	•		•		•						•				•	•			•	•	•	•	•	•	•	•	•
TX5M00CM-5	1/4"	Hi Temp ²	S			•		•						•				•	•			•	•	•	•	•	•	•	•	•
TX5M00EP-2	1/2"	Standard	S		•			•						•				•	•			•	•	•	•	•	•	•	•	•
TX5M00EP-3	1/2"	Standard	S		•				•					•				•	•			•	•	•	•	•	•	•	•	•
TX5M00EP-10	1/2"	Standard	H	•	•			•						•				•	•			•	•	•	•	•	•	•	•	•
TX5M00EM-1	1/2"	Standard	S			•		•						•				•	•			•	•	•	•	•	•	•	•	•
TX5M00EM-2	1/2"	Standard	S			•			•					•				•	•			•	•	•	•	•	•	•	•	•
TX5M00EP-4	1/2"	Coating Thickness	CT	•	•				•					•				•	•			•	•	•	•	•	•	•	•	•
TX5M00EP-5	1/2"	Hi Temp ²	S		•			•						•				•	•			•	•	•	•	•	•	•	•	•
TX5M00EM-3	1/2"	Hi Temp ³	S			•		•						•				•	•			•	•	•	•	•	•	•	•	•
TX5M00EM-4	1/2"	Hi Temp ²	S			•		•						•				•	•			•	•	•	•	•	•	•	•	•
TX5M00EP-6	1/2"	Hi Temp ²	H	•	•			•						•				•	•			•	•	•	•	•	•	•	•	•
TX5M00EL-1	1/2"	Armoured	S					•						•				•	•			•	•	•	•	•	•	•	•	•
TX5M00EP-1	1/2"	Cylinder Probe - Iron	S		•				•					•				•	•			•	•	•	•	•	•	•	•	•

1. Damping
 S - Standard Undamped Transducer
 H - Highly Damped Transducer
 R - Resolution Transducer

CT - Damped Coating Thickness Transducer
 M - Medium Damped Transducer
 HG - High Gain Damping Transducers
 HR - High Resolution Transducer

2. High temperature probes suitable for measuring 343°C (650°F)
 3. High temperature probes suitable for measuring 482°C (900°F)

Dual Element Thickness Transducers - Continued

Dual element transducer for a wide variety of precision thickness measurement applications.



Part Number	Probe Diameter	Probe Characteristic	Damping ¹	ThruPaint™	Connector Type						Suitable for measuring						Suitable for														
					Potted	Microdot	Lemo	Top	Side	End	Cast Iron	Plastics	Thin Plastics	Fibreglass	Thin Fibreglass	Steel	Glass	Aluminium	Titanium	VG10	CG10	CG20	CG30	CG50	CG60	CG70	CG100	FD700+			
7.50 MHz Dual Element Thickness Transducer																															
TX7M50BP-1	3/16"	Standard	S	•			•							•				•	•	•		•	•	•	•	•	•	•	•	•	•
TX7M50BP-2	3/16"	Standard	S	•				•						•				•	•	•		•	•	•	•	•	•	•	•	•	•
TX7M50BP-3	3/16"	Coating Thickness	CT	•	•			•						•				•	•	•		•	•	•	•	•	•	•	•	•	•
TX7M50CP-1	1/4"	Exxon Spec	S	•			•							•				•	•	•		•	•	•	•	•	•	•	•	•	•
TX7M50CP-2	1/4"	Exxon Spec	S	•				•						•				•	•	•		•	•	•	•	•	•	•	•	•	•
TX7M50CM-1	1/4"	Exxon Spec	S		•		•							•				•	•	•		•	•	•	•	•	•	•	•	•	•
TX7M50CM-2	1/4"	Exxon Spec	S		•			•						•				•	•	•		•	•	•	•	•	•	•	•	•	•
TX7M50CP-3	1/4"	Extra Resolution	S	•			•							•				•	•	•		•	•	•	•	•	•	•	•	•	•
TX7M50CP-4	1/4"	Extra Resolution	S	•				•						•				•	•	•		•	•	•	•	•	•	•	•	•	•
TX7M50CP-6	1/4"	Standard	H	•	•			•						•				•	•	•		•	•	•	•	•	•	•	•	•	•
TX7M50CP-5	1/4"	Coating Thickness	CT	•	•			•						•				•	•	•		•	•	•	•	•	•	•	•	•	•
TX7M50CM-3	1/4"	Extra Resolution	S		•		•							•				•	•	•		•	•	•	•	•	•	•	•	•	•
TX7M50CM-4	1/4"	Extra Resolution	S		•		•							•				•	•	•		•	•	•	•	•	•	•	•	•	•
10.00 MHz Dual Element Thickness Transducer																															
TX10M0BP-1	3/16"	Standard	S	•			•							•				•	•	•		•	•	•	•	•	•	•	•	•	•
TX10M0BP-2	3/16"	Standard	S	•			•							•				•	•	•		•	•	•	•	•	•	•	•	•	•
TX10M0CP-3	1/4"	Standard	S	•			•							•				•	•	•		•	•	•	•	•	•	•	•	•	•
TX10M0CP-4	1/4"	Standard	S	•				•						•				•	•	•		•	•	•	•	•	•	•	•	•	•
TX10M0CM-1	1/4"	Standard	S		•		•							•				•	•	•		•	•	•	•	•	•	•	•	•	•
TX10M0CM-2	1/4"	Standard	S		•			•						•				•	•	•		•	•	•	•	•	•	•	•	•	•
TX10M0CP-1	1/4"	Low Profile 1" Wand	S	•				•						•	•			•	•	•		•	•	•	•	•	•	•	•	•	•
TX10M0CP-2	1/4"	Low Profile 9" Wand	S	•				•						•	•			•	•	•		•	•	•	•	•	•	•	•	•	•
TX10M0EP-2	1/2"	Standard	S	•			•							•				•	•	•		•	•	•	•	•	•	•	•	•	•
TX10M0EP-3	1/2"	Standard	S	•				•						•				•	•	•		•	•	•	•	•	•	•	•	•	•
TX10M0EM-1	1/2"	Standard	S		•		•							•				•	•	•		•	•	•	•	•	•	•	•	•	•
TX10M0EM-2	1/2"	Standard	S		•			•						•				•	•	•		•	•	•	•	•	•	•	•	•	•
TX10M0EP-1	1/2"	Cylinder Probe - Alum	S	•				•						•	•			•	•	•		•	•	•	•	•	•	•	•	•	•

1. Damping
 S - Standard Undamped Transducer
 H - Highly Damped Transducer
 R - Resolution Transducer

CT - Damped Coating Thickness Transducer
 M - Medium Damped Transducer
 HG - High Gain Damping Transducers
 HR - High Resolution Transducer

2. High temperature probes suitable for measuring 343°C (650°F)
 3. High temperature probes suitable for measuring 482°C (900°F)

Underwater Gauge Transducers Specifications

Elcometer NDT offer a range of underwater material and coating thickness transducers, available with single membrane and dual elements, ideal for offshore inspections.



Part Number	Probe Diameter	Element Type	Probe Characteristic	Damping ¹	ThruPaint™	Connector Type						Suitable for measuring						Suitable for UG20DL		
						Potted	Microdot	Lemo - UW ⁴	Top	Side	End	Cast Iron	Plastics	Thin Plastics	Fibreglass	Thin Fibreglass	Steel		Glass	Aluminium
2.25 MHz Underwater Transducer																				
TX2M25EL-2	1/2"	Si/EI Membrane	Underwater	S				•	•							•	•	•	•	
3.50 MHz Underwater Transducer																				
TX3M50EP-3	1/2"	Dual	Underwater	S	•	•			•			•	•		•					•
5.00 MHz Underwater Transducer																				
TX5M00EL-2	1/2"	Si/EI Membrane	Underwater	S				•	•							•		•	•	•
TX5M00EP-8	1/2"	Dual	Underwater	S		•			•				•			•	•			•
TX5M00EP-9	1/2"	Dual	Underwater - 15m (50ft)	S		•			•				•			•	•			•

1. Damping
 S - Standard Undamped Transducer
 H - Highly Damped Transducer
 R - Resolution Transducer

CT - Damped Coating Thickness Transducer
 M - Medium Damped Transducer
 HG - High Gain Damping Transducers
 HR - High Resolution Transducer

2. High temperature probes suitable for measuring 343°C (650°F)
 3. High temperature probes suitable for measuring 482°C (900°F)
 4. Lemo UW - Lemo Underwater Connection

When pinpoint accuracy is the key, the Elcometer NDT range of precision gauge transducers allow users to measure with precision.



Single Element Precision Transducers

Single element transducer for a wide variety of precision thickness measurement applications.



Part Number	Probe Diameter	Element Type	Probe Characteristic	Damping ¹	ThruPaint™	Connector Type						Suitable for measuring						Suitable for				
						Potted	Microdot	Lemo	Top	Side	End	Cast Iron	Plastics	Thin Plastics	Fibreglass	Thin Fibreglas	Steel	Glass	Aluminium	Titanium	PG70	PG70DL
2.25 MHz Single Element Precision Transducer																						
TX2M25CM-4	1/4"	Si/EI Contact	Standard	S			•					•					•	•	•	•	•	•
TX2M25EM-4	1/2"	Si/EI Contact	Standard	S			•					•					•	•	•	•	•	•
5.00 MHz Single Element Precision Transducer																						
TX5M00AM-1	1/8"	Si/EI Contact	Standard	S			•					•					•	•	•	•	•	•
TX5M00CM-6	1/4"	Si/EI Contact	Standard	S			•					•					•	•	•	•	•	•
TX5M00EM-5	1/2"	Si/EI Contact	Standard	S			•					•					•	•	•	•	•	•
10.00 MHz Single Element Precision Transducer																						
TX10M0BM-1	3/16"	Si/EI D/Line Pencil	1/16" Tip	S			•		•				•				•	•	•	•	•	•
TX10M0BM-2	3/16"	Si/EI D/Line Pencil	90° Right Angle	S			•						•				•	•	•	•	•	•
TX10M0CM-3	1/4"	Si/EI Contact	Standard	S			•					•					•	•	•	•	•	•
TX10M0AM-1	1/8"	Si/EI Contact	Standard	S			•					•					•	•	•	•	•	•
15.00 MHz Single Element Precision Transducer																						
TX15M0CM	1/4"	Si/EI Delay Line	Standard	S			•					•					•	•	•	•	•	•
20.00 MHz Single Element Precision Transducer																						
TX20M0CM	1/4"	Si/EI Delay Line	Standard	S			•					•					•	•	•	•	•	•

1. Damping
 S - Standard Undamped Transducer
 H - Highly Damped Transducer
 R - Resolution Transducer

CT - Damped Coating Thickness Transducer
 M - Medium Damped Transducer
 HG - High Gain Damping Transducers
 HR - High Resolution Transducer

2. High temperature probes suitable for measuring 343°C (650°F)
 3. High temperature probes suitable for measuring 482°C (900°F)

Sonic Gauge Transducers

Specifications

Specially designed for the automotive industry the Elcometer NDT range of sonic gauge transducers are ideal for measuring the thickness of cylinder walls, intake or exhaust ports, chassis, tubing, body panels, and windscreens.



Dual Element Sonic Transducers

Dual element transducer for a wide variety of thickness measurement applications.



Part Number	Diameter	Characteristic	Damping ¹	ThruPaint™	Connector Type						Suitable for measuring							Suitable for			
					Potted	Microdot	Lemo	Top	Side	End	Cast Iron	Plastics	Thin Plastics	Fibreglass	Thin Fibreglas	Steel	Glass	Aluminium	Titanium	VG10	SG80
1.00 MHz Dual Element Sonic Transducers																					
TX1M00EP-1	1/2"	Standard	S		•			•			•	•		•					•	•	•
TX1M00EP-2	1/2"	Standard	S		•				•		•	•		•					•	•	•
TX1M00EM-1	1/2"	Standard	S			•		•			•	•		•					•	•	•
TX1M00EM-2	1/2"	Standard	S			•			•		•	•		•					•	•	•
TX1M00EP-3	1/2"	Composite	S		•				•		•	•		•					•	•	•
TX1M00EL	1/2"	Armoured	S					•			•	•		•					•	•	•
2.25 MHz Dual Element Sonic Transducers																					
TX2M25CP-1	1/4"	Standard	S		•			•			•	•		•					•	•	•
TX2M25CP-2	1/4"	Standard	S		•				•		•	•		•					•	•	•
TX2M25CM-1	1/4"	Standard	S			•		•			•	•		•					•	•	•
TX2M25CM-2	1/4"	Standard	S			•			•		•	•		•					•	•	•
TX2M25CP-3	1/4"	Hi Temp ²	S		•			•			•	•		•					•	•	•
TX2M25CM-3	1/4"	Hi Temp ²	S			•		•			•	•		•					•	•	•
TX2M25EP-1	1/2"	Standard	S		•			•			•	•		•					•	•	•
TX2M25EP-2	1/2"	Standard	S		•				•		•	•		•					•	•	•
TX2M25EM-1	1/2"	Standard	S			•		•			•	•		•					•	•	•
TX2M25EM-2	1/2"	Standard	S			•			•		•	•		•					•	•	•
TX2M25EP-3	1/2"	Hi Temp ²	S		•			•			•	•		•					•	•	•
TX2M25EM-3	1/2"	Hi Temp ²	S			•		•			•	•		•					•	•	•
TX2M25EP-4	1/2"	Composite	S		•				•		•	•		•					•	•	•
TX2M25EL-1	1/2"	Armoured	S					•			•	•		•					•	•	•
3.50 MHz Dual Element Sonic Transducers																					
TX3M50EP-4	1/2"	Standard	H	•	•				•		•	•		•					•	•	•
TX3M50EP-1	1/2"	Coating Thickness	CT	•	•				•		•	•		•					•	•	•
TX3M50EL	1/2"	Armoured	S					•			•	•		•					•	•	•

1. Damping
 S - Standard Undamped Transducer
 H - Highly Damped Transducer
 R - Resolution Transducer

CT - Damped Coating Thickness Transducer
 M - Medium Damped Transducer
 HG - High Gain Damping Transducers
 HR - High Resolution Transducer

2. High temperature probes suitable for measuring 343°C (650°F)
 3. High temperature probes suitable for measuring 482°C (900°F)

Sonic Gauge Transducers

Dual Element Sonic Transducers - Continued

Dual element transducer for a wide variety of thickness measurement applications.



Part Number	Diameter	Characteristic	Damping ¹	ThruPaint™	Connector Type							Suitable for measuring							Suitable for			
					Potted	Microdot	Lemo	Top	Side	End	Cast Iron	Plastics	Thin Plastics	Fibreglass	Thin Fibreglas	Steel	Glass	Aluminium	Titanium	VG10	SG80	SG80BDL
5.00 MHz Dual Element Sonic Transducers																						
TX5M00BP-1	3/16"	Low Profile	S		•				•		•				•	•				•	•	
TX5M00BP-2	3/16"	Standard	S		•			•							•	•				•	•	•
TX5M00BP-3	3/16"	Standard	S		•				•						•	•				•	•	•
TX5M00BP-5	3/16"	Standard	H	•	•				•						•	•				•	•	•
TX5M00BP-4	3/16"	Coating Thickness	CT	•	•				•						•	•				•	•	•
TX5M00BM	3/16"	Standard	S			•			•						•	•				•	•	•
TX5M00CP-1	1/4"	Low Profile 1" Wand	S		•				•		•				•	•					•	•
TX5M00CP-2	1/4"	Low Profile 9" Wand	S		•				•		•				•	•					•	•
TX5M00CP-3	1/4"	Standard	S		•			•							•	•				•	•	•
TX5M00CP-9	1/4"	Standard	H	•	•			•							•	•				•	•	•
TX5M00CP-4	1/4"	Standard	S		•				•		•				•	•				•	•	•
TX5M00CP-5	1/4"	Super Standard	S		•				•						•	•				•	•	•
TX5M00CP-10	1/4"	Standard	H	•	•				•		•				•	•				•	•	•
TX5M00CP-6	1/4"	Coating Thickness	CT	•	•				•						•	•				•	•	•
TX5M00CM-1	1/4"	Standard	S			•		•							•	•				•	•	•
TX5M00CM-2	1/4"	Standard	S			•			•						•	•				•	•	•
TX5M00CM-9	1/4"	Standard	H	•		•			•						•	•				•	•	•
TX5M00CM-3	1/4"	Coating Thickness	CT	•		•			•						•	•				•	•	•
TX5M00CP-7	1/4"	Hi Temp ²	S		•			•							•	•				•	•	•
TX5M00CP-8	1/4"	Hi Temp ²	H	•	•			•							•	•				•	•	•
TX5M00CM-4	1/4"	Hi Temp ³	S	•		•		•							•	•				•	•	•
TX5M00CM-5	1/4"	Hi Temp ²	S			•		•							•	•				•	•	•
TX5M00EP-1	1/2"	Cylinder Probe - Iron	S		•				•		•				•	•					•	•
TX5M00EP-2	1/2"	Standard	S		•			•							•	•				•	•	•
TX5M00EP-3	1/2"	Standard	S		•				•						•	•				•	•	•
TX5M00EP-10	1/2"	Standard	H	•	•				•						•	•				•	•	•
TX5M00EP-4	1/2"	Coating Thickness	CT	•	•				•						•	•				•	•	•
TX5M00EM-1	1/2"	Standard	S			•		•							•	•				•	•	•
TX5M00EM-2	1/2"	Standard	S			•			•						•	•				•	•	•
TX5M00EP-5	1/2"	Hi Temp ²	S		•			•							•	•				•	•	•
TX5M00EM-3	1/2"	Hi Temp ³	S			•		•							•	•				•	•	•
TX5M00EM-4	1/2"	Hi Temp ²	S			•		•							•	•				•	•	•
TX5M00EP-6	1/2"	Hi Temp ²	H	•	•			•							•	•				•	•	•
TX5M00EL-1	1/2"	Armoured	S				•		•						•	•				•	•	•

1. Damping
 S - Standard Undamped Transducer
 H - Highly Damped Transducer
 R - Resolution Transducer

CT - Damped Coating Thickness Transducer
 M - Medium Damped Transducer
 HG - High Gain Damping Transducers
 HR - High Resolution Transducer

2. High temperature probes suitable for measuring 343°C (650°F)
 3. High temperature probes suitable for measuring 482°C (900°F)

Flaw Detection Transducers

Elcometer NDT offer a state-of-the-art range of flaw detection transducers.

To order suitable thickness transducers for use with the FD700+ flaw detection range please refer to page 40.



Single Element Contact Transducers

Single element transducer for a wide variety of precision thickness measurement applications.



Part Number	Probe Diameter	Probe Characteristic	Damping ¹	Connector Type											Suitable for measuring														
				Microdot	Lemo	BNC	Top	Side	End	Cast Iron	Plastics	Thin Plastics	Fibreglass	Thin Fibreglas	Steel	Glass	Aluminium	Titanium	All Metals	Common Metals	Rough Surfaces	Castings	Billets	Extruded Parts	Weld Inspection	Weld Inspection (Tight Areas)	Immersion & Bubbler Inspections	FD700+	FD700DL+
1.00 MHz Single Element Contact Transducers																													
TF1M00EM-1	1/2"	High Wear Composite	M		•																							•	•
TF1M00GM-1	3/4"	High Wear Composite	M		•																							•	•
TF1M00HM-1	1"	High Wear Composite	M		•																							•	•
TF1M00EM-2	1/2"	High Wear Composite	M	•																								•	•
TF1M00GM-2	3/4"	High Wear Composite	M	•																								•	•
TF1M00HM-2	1"	High Wear Composite	M	•																								•	•
TF1M00EG	1/2"	Membrane Composite	HG		•																							•	•
TF1M00HG	1"	Membrane Composite	HG		•																							•	•
TF1M00EH-1	1/2"	Composite	H		•																							•	•
TF1M00GH-1	3/4"	Composite	H		•																							•	•
TF1M00HH-1	1"	Composite	H		•																							•	•
TF1M00EH-2	1/2"	Composite	H	•																								•	•
TF1M00GH-2	3/4"	Composite	H	•																								•	•
TF1M00HH-2	1"	Composite	H	•																								•	•
TF1M00C-1	1/4"	Finger Tip Composite	S	•				•																				•	•
TF1M00C-2	1/4"	Finger Tip Composite	S	•			•																					•	•
TF1M00E-1	1/2"	Finger Tip Composite	S	•				•																				•	•
TF1M00E-2	1/2"	Finger Tip Composite	S	•			•																					•	•

1. Damping
 S - Standard Undamped Transducer
 H - Highly Damped Transducer
 R - Resolution Transducer

CT - Damped Coating Thickness Transducer
 M - Medium Damped Transducer
 HG - High Gain Damping Transducers
 HR - High Resolution Transducer

2. High temperature probes suitable for measuring 343°C (650°F)
 3. High temperature probes suitable for measuring 482°C (900°F)

Single Element Contact Transducers - Continued

Single element transducer for a wide variety of precision thickness measurement applications.



Part Number	Probe Diameter	Probe Characteristic	Damping	Connector Type						Suitable for measuring																													
				Microdot	Lemo	BNC	Top	Side	End	Cast Iron	Plastics	Thin Plastics	Fibreglass	Thin Fibreglas	Steel	Glass	Aluminium	Titanium	All Metals	Common Metals	Rough Surfaces	Castings	Billets	Extruded Parts	Weld Inspection	Weld Inspection (Tight Areas)	Immersion & Bubbler Inspections	FD700+	FD700DL+										
2.25 MHz Single Element Contact Transducers																																							
TF2M25EM-1	1/2"	High Wear	M			•																													•	•			
TF2M25GM-1	3/4"	High Wear	M			•																														•	•		
TF2M25HM-1	1"	High Wear	M			•																														•	•		
TF2M25EM-2	1/2"	High Wear	M		•																															•	•		
TF2M25GM-2	3/4"	High Wear	M		•																																•	•	
TF2M25HM-2	1"	High Wear	M		•																																•	•	
TF2M25EG-3	1/2"	Membrane	HG			•																															•	•	
TF2M25HG-1	1"	Membrane	HG			•																															•	•	
TF2M25EH-1	1/2"	High Wear	H			•																															•	•	
TF2M25GH-1	3/4"	High Wear	H			•																															•	•	
TF2M25HH-1	1"	High Wear	H			•																															•	•	
TF2M25EH-2	1/2"	High Wear	H		•																																•	•	
TF2M25GH-2	3/4"	High Wear	H		•																																•	•	
TF2M25HH-2	1"	High Wear	H		•																																•	•	
TF2M25CG-1	1/4"	Finger Tip	HG	•						•																											•	•	
TF2M25DG-1	3/8"	Finger Tip	HG	•						•																												•	•
TF2M25EG-1	1/2"	Finger Tip	HG	•						•																												•	•
TF2M25GG-1	3/4"	Finger Tip	HG	•						•																												•	•
TF2M25CG-2	1/4"	Finger Tip	HG	•						•																												•	•
TF2M25DG-2	3/8"	Finger Tip	HG	•						•																												•	•
TF2M25EG-2	1/2"	Finger Tip	HG	•						•																												•	•
TF2M25GG-2	3/4"	Finger Tip	HG	•						•																												•	•
TF2M25CR-1	1/4"	Finger Tip	R	•						•																												•	•
TF2M25DR-1	3/8"	Finger Tip	R	•						•																												•	•
TF2M25ER-1	1/2"	Finger Tip	R	•						•																												•	•
TF2M25GR-1	3/4"	Finger Tip	R	•						•																												•	•
TF2M25CR-2	1/4"	Finger Tip	R	•						•																												•	•
TF2M25DR-2	3/8"	Finger Tip	R	•						•																												•	•
TF2M25ER-2	1/2"	Finger Tip	R	•						•																												•	•
TF2M25GR-2	3/4"	Finger Tip	R	•						•																												•	•

1. Damping
 S - Standard Undamped Transducer
 H - Highly Damped Transducer
 R - Resolution Transducer

CT - Damped Coating Thickness Transducer
 M - Medium Damped Transducer
 HG - High Gain Damping Transducers
 HR - High Resolution Transducer

2. High temperature probes suitable for measuring 343°C (650°F)
 3. High temperature probes suitable for measuring 482°C (900°F)

Flaw Detection Transducers

Single Element Contact Transducers - Continued

Single element transducer for a wide variety of precision thickness measurement applications.



Part Number	Probe Diameter	Probe Characteristic	Damping	Connector Type						Suitable for measuring																				
				Microdot	Lemo	BNC	Top	Side	End	Cast Iron	Plastics	Thin Plastics	Fibreglass	Thin Fibreglas	Steel	Glass	Aluminium	Titanium	All Metals	Common Metals	Rough Surfaces	Castings	Billets	Extruded Parts	Weld Inspection	Weld Inspection (Tight Areas)	Immersion & Bubbler Inspections	FD700+	FD700DL+	
3.50 MHz Single Element Contact Transducers																														
TF3M50EM-1	1/2"	High Wear Composite	M			•																							•	•
TF3M50GM-1	3/4"	High Wear Composite	M			•																							•	•
TF3M50HM-1	1"	High Wear Composite	M			•																							•	•
TF3M50EM-2	1/2"	High Wear Composite	M	•																									•	•
TF3M50GM-2	3/4"	High Wear Composite	M	•																									•	•
TF3M50HM-2	1"	High Wear Composite	M	•																									•	•
TF3M50EG	1/2"	Membrane Composite	HG			•																							•	•
TF3M50HG	1"	Membrane Composite	HG			•																							•	•
TF3M50EH-1	1/2"	Composite	H			•																							•	•
TF3M50GH-1	3/4"	Composite	H			•																							•	•
TF3M50HH-1	1"	Composite	H			•																							•	•
TF3M50EH-2	1/2"	Composite	H	•																									•	•
TF3M50GH-2	3/4"	Composite	H	•																									•	•
TF3M50HH-2	1"	Composite	H	•																									•	•
TF3M50C-1	1/4"	Finger Tip Composite	S	•				•			•																		•	•
TF3M50D-1	3/8"	Finger Tip Composite	S	•				•			•																		•	•
TF3M50E-1	1/2"	Finger Tip Composite	S	•				•			•																		•	•
TF3M50G-1	3/4"	Finger Tip Composite	S	•				•			•																		•	•
TF3M50C-2	1/4"	Finger Tip Composite	S	•			•				•																		•	•
TF3M50D-2	3/8"	Finger Tip Composite	S	•			•				•																		•	•
TF3M50E-2	1/2"	Finger Tip Composite	S	•			•				•																		•	•
TF3M50G-2	3/4"	Finger Tip Composite	S	•			•				•																		•	•

1. Damping
 S - Standard Undamped Transducer
 H - Highly Damped Transducer
 R - Resolution Transducer

CT - Damped Coating Thickness Transducer
 M - Medium Damped Transducer
 HG - High Gain Damping Transducers
 HR - High Resolution Transducer

2. High temperature probes suitable for measuring 343°C (650°F)
 3. High temperature probes suitable for measuring 482°C (900°F)

Single Element Contact Transducers - Continued

Single element transducer for a wide variety of precision thickness measurement applications.



Part Number	Probe Diameter	Probe Characteristic	Damping ¹	Connector Type						Suitable for measuring																							
				Microdot	Lemo	BNC	Top	Side	End	Cast Iron	Plastics	Thin Plastics	Fibreglass	Thin Fibreglas	Steel	Glass	Aluminium	Titanium	All Metals	Common Metals	Rough Surfaces	Castings	Billets	Extruded Parts	Weld Inspection	Weld Inspection (Tight Areas)	Immersion & Bubbler Inspections	FD700+	FD700DL+				
5.00 MHz Single Element Contact Transducers																																	
TF5M00EM-1	1/2"	High Wear	M		•																		•	•	•	•						•	•
TF5M00GM-1	3/4"	High Wear	M		•																		•	•	•	•						•	•
TF5M00HM-1	1"	High Wear	M		•																		•	•	•	•						•	•
TF5M00EM-2	1/2"	High Wear	M	•																			•	•	•	•						•	•
TF5M00GM-2	3/4"	High Wear	M	•																			•	•	•	•						•	•
TF5M00HM-2	1"	High Wear	M	•																			•	•	•	•						•	•
TF5M00EH-1	1/2"	High Wear	H		•																		•	•	•	•						•	•
TF5M00GH-1	3/4"	High Wear	H		•																		•	•	•	•						•	•
TF5M00HH-1	1"	High Wear	H		•																		•	•	•	•						•	•
TF5M00EH-2	1/2"	High Wear	H	•																			•	•	•	•						•	•
TF5M00GH-2	3/4"	High Wear	H	•																			•	•	•	•						•	•
TF5M00HH-2	1"	High Wear	H	•																			•	•	•	•						•	•
TF5M00EG-3	1/2"	Membrane	HG		•																		•	•								•	•
TF5M00HG-1	1"	Membrane	HG		•																		•	•								•	•
TF5M00CG-1	1/4"	Finger Tip	HG	•			•			•													•									•	•
TF5M00DG-1	3/8"	Finger Tip	HG	•			•			•													•									•	•
TF5M00EG-1	1/2"	Finger Tip	HG	•			•			•													•									•	•
TF5M00GG-1	3/4"	Finger Tip	HG	•			•			•													•									•	•
TF5M00CG-2	1/4"	Finger Tip	HG	•			•			•													•									•	•
TF5M00DG-2	3/8"	Finger Tip	HG	•			•			•													•									•	•
TF5M00EG-2	1/2"	Finger Tip	HG	•			•			•													•									•	•
TF5M00GG-2	3/4"	Finger Tip	HG	•			•			•													•									•	•
TF5M00CR-1	1/4"	Finger Tip	R	•			•			•													•									•	•
TF5M00DR-1	3/8"	Finger Tip	R	•			•			•													•									•	•
TF5M00ER-1	1/2"	Finger Tip	R	•			•			•													•									•	•
TF5M00GR-1	3/4"	Finger Tip	R	•			•			•													•									•	•
TF5M00CR-2	1/4"	Finger Tip	R	•			•			•													•									•	•
TF5M00DR-2	3/8"	Finger Tip	R	•			•			•													•									•	•
TF5M00ER-2	1/2"	Finger Tip	R	•			•			•													•									•	•
TF5M00GR-2	3/4"	Finger Tip	R	•			•			•													•									•	•
TF5M00AH-1	1/8"	Finger Tip Slim Line	H	•			•			•													•									•	•
TF5M00AH-2	1/8"	Finger Tip Slim Line	H	•			•			•													•									•	•

1. Damping
 S - Standard Undamped Transducer
 H - Highly Damped Transducer
 R - Resolution Transducer

CT - Damped Coating Thickness Transducer
 M - Medium Damped Transducer
 HG - High Gain Damping Transducers
 HR - High Resolution Transducer

2. High temperature probes suitable for measuring 343°C (650°F)
 3. High temperature probes suitable for measuring 482°C (900°F)

Flaw Detection Transducers

Single Element Contact Transducers - Continued

Single element transducer for a wide variety of precision thickness measurement applications.



Part Number	Probe Diameter	Probe Characteristic	Damping ¹	Connector Type						Suitable for measuring																			
				Microdot	Lemo	BNC	Top	Side	End	Cast Iron	Plastics	Thin Plastics	Fibreglass	Thin Fibreglas	Steel	Glass	Aluminium	Titanium	All Metals	Common Metals	Rough Surfaces	Castings	Billets	Extruded Parts	Weld Inspection	Weld Inspection (Tight Areas)	Immersion & Bubbler Inspections	FD700+	FD700DL+
10.00 MHz Single Element Contact Transducers																													
TF10M0CG-1	1/4"	Finger Tip	HG	•				•		•																		•	•
TF10M0DG-1	3/8"	Finger Tip	HG	•				•		•																		•	•
TF10M0EG-1	1/2"	Finger Tip	HG	•				•		•																		•	•
TF10M0CG-2	1/4"	Finger Tip	HG	•			•			•																		•	•
TF10M0DG-2	3/8"	Finger Tip	HG	•			•			•																		•	•
TF10M0EG-2	1/2"	Finger Tip	HG	•			•			•																		•	•
TF10M0CR-1	1/4"	Finger Tip	R	•				•		•																		•	•
TF10M0DR-1	3/8"	Finger Tip	R	•				•		•																		•	•
TF10M0ER-1	1/2"	Finger Tip	R	•				•		•																		•	•
TF10M0CR-2	1/4"	Finger Tip	R	•			•			•																		•	•
TF10M0DR-2	3/8"	Finger Tip	R	•			•			•																		•	•
TF10M0ER-2	1/2"	Finger Tip	R	•			•			•																		•	•
TF10M0AH-1	1/8"	Finger Tip Slim Line	H	•				•		•																		•	•
TF10M0AH-2	1/8"	Finger Tip Slim Line	H	•			•			•																		•	•
15.00 MHz Single Element Contact Transducers																													
TF15M0AH-1	1/8"	Finger Tip Slim Line	H	•				•		•																		•	•
TF15M0AH-2	1/8"	Finger Tip Slim Line	H	•			•			•																		•	•
20.00 MHz Single Element Contact Transducers																													
TF20M0AH-1	1/8"	Finger Tip Slim Line	H	•				•		•																		•	•
TF20M0AH-2	1/8"	Finger Tip Slim Line	H	•			•			•																		•	•

1. Damping
 S - Standard Undamped Transducer
 H - Highly Damped Transducer
 R - Resolution Transducer

CT - Damped Coating Thickness Transducer
 M - Medium Damped Transducer
 HG - High Gain Damping Transducers
 HR - High Resolution Transducer

2. High temperature probes suitable for measuring 343°C (650°F)
 3. High temperature probes suitable for measuring 482°C (900°F)

Shear Wave Dual Transducers

Dual element transducers with high near surface resolution. Ideal for identifying surface cracks and weld inspections. A variety of angles are available.



Part Number	Probe Diameter	Angle* - 45°, 60° & 70°	Probe Characteristic	Damping ¹	Microdot	Top	Side	End	Suitable for measuring																		
									Cast Iron	Plastics	Thin Plastics	Fibreglass	Thin Fibreglas	Steel	Glass	Aluminium	Titanium	All Metals	Common Metals	Rough Surfaces	Castings	Billets	Extruded Parts	Weld Inspection	Weld Inspection (Tight Areas)	Immersion & Bubbler Inspections	FD700+
1.00 MHz Shear Wave - Dual Transducers																											
TF1M00CC##M-1	1/4 x 1/4"	○	Composite	M	●			●																		●	●
TF1M00CD##M-1	1/4 x 3/8"	○	Composite	M	●			●																		●	●
TF1M00DD##M-1	3/8 x 3/8"	○	Composite	M	●			●																		●	●
TF1M00EE##M-1	1/2 x 1/2"	○	Composite	M	●			●																		●	●
TF1M00CC##M-2	1/4 x 1/4"	○	Composite	M	●	●																				●	●
TF1M00CD##M-2	1/4 x 3/8"	○	Composite	M	●	●																				●	●
TF1M00DD##M-2	3/8 x 3/8"	○	Composite	M	●	●																				●	●
TF1M00EE##M-2	1/2 x 1/2"	○	Composite	M	●	●																				●	●
2.25 MHz Shear Wave - Dual Transducers																											
TF2M25CC##M-1	1/4 x 1/4"	○	Standard	M	●			●																		●	●
TF2M25CD##M-1	1/4 x 3/8"	○	Standard	M	●			●																		●	●
TF2M25DD##M-1	3/8 x 3/8"	○	Standard	M	●			●																		●	●
TF2M25EE##M-1	1/2 x 1/2"	○	Standard	M	●			●																		●	●
TF2M25CC##M-2	1/4 x 1/4"	○	Standard	M	●	●																				●	●
TF2M25CD##M-2	1/4 x 3/8"	○	Standard	M	●	●																				●	●
TF2M25DD##M-2	3/8 x 3/8"	○	Standard	M	●	●																				●	●
TF2M25EE##M-2	1/2 x 1/2"	○	Standard	M	●	●																				●	●
5.00 MHz Shear Wave - Dual Transducers																											
TF5M00CC##M-1	1/4 x 1/4"	○	Standard	M	●			●																		●	●
TF5M00CD##M-1	1/4 x 3/8"	○	Standard	M	●			●																		●	●
TF5M00DD##M-1	3/8 x 3/8"	○	Standard	M	●			●																		●	●
TF5M00EE##M-1	1/2 x 1/2"	○	Standard	M	●			●																		●	●
TF5M00CC##M-2	1/4 x 1/4"	○	Standard	M	●	●																				●	●
TF5M00CD##M-2	1/4 x 3/8"	○	Standard	M	●	●																				●	●
TF5M00DD##M-2	3/8 x 3/8"	○	Standard	M	●	●																				●	●
TF5M00EE##M-2	1/2 x 1/2"	○	Standard	M	●	●																				●	●

* Shear Wave Transducers are available in 45, 60 & 70 angles. Replace ## within the part number with 45 for the 45° angle, 60 for the 60° degree angle and 70 for the 70° angle.

1. Damping
S - Standard Undamped Transducer
H - Highly Damped Transducer
R - Resolution Transducer

CT - Damped Coating Thickness Transducer
M - Medium Damped Transducer
HG - High Gain Damping Transducers
HR - High Resolution Transducer

2. High temperature probes suitable for measuring 343°C (650°F)
3. High temperature probes suitable for measuring 482°C (900°F)

Flaw Detection Transducers

Shear Wave Mini Transducers

A smaller single element probe for higher precision.

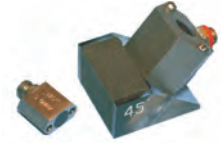

Part Number	Probe Diameter	Damping ¹	Microdot	Suitable for measuring																		
				Cast Iron	Plastics	Thin Plastics	Fibreglass	Thin Fibreglas	Steel	Glass	Aluminium	Titanium	All Metals	Common Metals	Rough Surfaces	Castings	Billets	Extruded Parts	Weld Inspection	Weld Inspection (Tight Areas)	Immersion & Bubbler Inspections	FD700+
2.25 MHz Shear Wave Mini Transducers																						
TF2M25AG	1/8"	HG	•															•			•	•
TF2M25CG-3	1/4"	HG	•															•			•	•
TF2M25DG-3	3/8"	HG	•															•			•	•
TF2M25EG-4	1/2"	HG	•															•			•	•
TF2M25AR	1/8"	R	•															•			•	•
TF2M25CR-3	1/4"	R	•															•			•	•
TF2M25DR-3	3/8"	R	•															•			•	•
TF2M25ER-3	1/2"	R	•															•			•	•
5.00 MHz Shear Wave Mini Transducers																						
TF5M00AG	1/8"	HG	•															•			•	•
TF5M00CG-3	1/4"	HG	•															•			•	•
TF5M00DG-3	3/8"	HG	•															•			•	•
TF5M00EG-4	1/2"	HG	•															•			•	•
TF5M00AR	1/8"	R	•															•			•	•
TF5M00CR-3	1/4"	R	•															•			•	•
TF5M00DR-3	3/8"	R	•															•			•	•
TF5M00ER-3	1/2"	R	•															•			•	•
10.00 MHz Shear Wave Mini Transducers																						
TF10M0AG	1/8"	HG	•															•			•	•
TF10M0CG-3	1/4"	HG	•															•			•	•
TF10M0DG-3	3/8"	HG	•															•			•	•
TF10M0EG-3	1/2"	HG	•															•			•	•
TF10M0AR	1/8"	R	•															•			•	•
TF10M0CR-3	1/4"	R	•															•			•	•
TF10M0DR-3	3/8"	R	•															•			•	•
TF10M0ER-3	1/2"	R	•															•			•	•

1. Damping
 S - Standard Undamped Transducer
 H - Highly Damped Transducer
 R - Resolution Transducer

CT - Damped Coating Thickness Transducer
 M - Medium Damped Transducer
 HG - High Gain Damping Transducers
 HR - High Resolution Transducer

2. High temperature probes suitable for measuring 343°C (650°F)
 3. High temperature probes suitable for measuring 482°C (900°F)

Shear Wave - Quick Change Transducers

Single element transducer with threaded tip allowing angle beam wedges to be changed with minimum delay. Ideal for curved surfaces and hard to reach areas.



Part Number	Probe Diameter	Probe Characteristic	Damping ¹	Microdot	Suitable for measuring																
					Cast Iron	Plastics	Thin Plastics	Fibreglass	Thin Fibreglas	Steel	Glass	Aluminium	Titanium	All Metals	Common Metals	Rough Surfaces	Castings	Billets	Extruded Parts	Weld Inspection	Weld Inspection (Tight Areas)
1.00MHz Shear Wave - Quick Change Transducers																					
TF1M00CG	1/4"	Composite	HG	•																•	•
TF1M00DG	3/8"	Composite	HG	•																•	•
TF1M00EG	1/2"	Composite	HG	•																•	•
TF1M00CR	1/4"	Composite	R	•																•	•
TF1M00DR	3/8"	Composite	R	•																•	•
TF1M00ER	1/2"	Composite	R	•																•	•
2.25 MHz Shear Wave - Quick Change Transducers																					
TF2M25CG-4	1/4"	Standard	HG	•																•	•
TF2M25DG-4	3/8"	Standard	HG	•																•	•
TF2M25EG-5	1/2"	Standard	HG	•																•	•
TF2M25CR-4	1/4"	Standard	R	•																•	•
TF2M25DR-4	3/8"	Standard	R	•																•	•
TF2M25ER-4	1/2"	Standard	R	•																•	•
TF2M25CG-6	1/4"	Composite	HG	•																•	•
TF2M25DG-6	3/8"	Composite	HG	•																•	•
TF2M25EG-7	1/2"	Composite	HG	•																•	•
TF2M25CR-6	1/4"	Composite	R	•																•	•
TF2M25DR-6	3/8"	Composite	R	•																•	•
TF2M25ER-6	1/2"	Composite	R	•																•	•
3.50 MHz Shear Wave - Quick Change Transducers																					
TF3M50E-3	1/2"	Composite	S	•																•	•
5.00 MHz Shear Wave - Quick Change Transducers																					
TF5M00CG-4	1/4"	Standard	HG	•																•	•
TF5M00DG-4	3/8"	Standard	HG	•																•	•
TF5M00EG-5	1/2"	Standard	HG	•																•	•
TF5M00CR-4	1/4"	Standard	R	•																•	•
TF5M00DR-4	3/8"	Standard	R	•																•	•
TF5M00ER-4	1/2"	Standard	R	•																•	•
TF5M00CG-6	1/4"	Composite	HG	•																•	•
TF5M00DG-6	3/8"	Composite	HG	•																•	•
TF5M00EG-7	1/2"	Composite	HG	•																•	•
TF5M00CR-6	1/4"	Composite	R	•																•	•
TF5M00DR-6	3/8"	Composite	R	•																•	•
TF5M00ER-6	1/2"	Composite	R	•																•	•
10.00 MHz Shear Wave - Quick Change Transducers																					
TF10M0CG-4	1/4"	Standard	HG	•																•	•
TF10M0DG-4	3/8"	Standard	HG	•																•	•
TF10M0EG-4	1/2"	Standard	HG	•																•	•
TF10M0CR-4	1/4"	Standard	R	•																•	•
TF10M0DR-4	3/8"	Standard	R	•																•	•
TF10M0ER-4	1/2"	Standard	R	•																•	•
TF10M0CG-6	1/4"	Composite	HG	•																•	•
TF10M0CR-6	1/4"	Composite	R	•																•	•

Flaw Detection Transducers

Mini Angle Beam Potted Transducers

Mini shear wave transducer with angle beam wedge pre-attached. A variety of angles are available



Part Number	Probe Diameter	Angle	Probe Characteristic	Damping ¹	Connection				Suitable for measuring																			
					Microdot	Top	Side	End	Cast Iron	Plastics	Thin Plastics	Fibreglass	Thin Fibreglas	Steel	Glass	Aluminium	Titanium	All Metals	Common Metals	Rough Surfaces	Castings	Billets	Extruded Parts	Weld Inspection	Weld Inspection (Tight Areas)	Immersion & Bubbler Inspections	FD700+	FD700DL+
2.25 MHz Mini Angle Beam Potted Transducers																												
TF2M25B45M	3/16"	45°		M	•	•																			•		•	•
TF2M25C45M	1/4"	45°		M	•	•																			•		•	•
TF2M25D45M	3/8"	45°		M	•	•																			•		•	•
TF2M25B60M	3/16"	60°		M	•	•																			•		•	•
TF2M25C60M	1/4"	60°		M	•	•																			•		•	•
TF2M25D60M	3/8"	60°		M	•	•																			•		•	•
TF2M25B70M	3/16"	70°		M	•	•																			•		•	•
TF2M25C70M	1/4"	70°		M	•	•																			•		•	•
TF2M25D70M	3/8"	70°		M	•	•																			•		•	•
5.00 MHz Mini Angle Beam Potted Transducers																												
TF5M00B45M-1	3/16"	45°		M	•	•																			•		•	•
TF5M00C45M	1/4"	45°		M	•	•																			•		•	•
TF5M00D45M	3/8"	45°		M	•	•																			•		•	•
TF5M00B60M-1	3/16"	60°		M	•	•																			•		•	•
TF5M00C60M	1/4"	60°		M	•	•																			•		•	•
TF5M00D60M	3/8"	60°		M	•	•																			•		•	•
TF5M00B70M-1	3/16"	70°		M	•	•																			•		•	•
TF5M00C70M	1/4"	70°		M	•	•																			•		•	•
TF5M00D70M	3/8"	70°		M	•	•																			•		•	•
10.0 MHz Mini Angle Beam Potted Transducers																												
TF10M0B45M-1	3/16"	45°		M	•	•																			•		•	•
TF10M0C45M	1/4"	45°		M	•	•																			•		•	•
TF10M0D45M	3/8"	45°		M	•	•																			•		•	•
TF10M0B60M-1	3/16"	60°		M	•	•																			•		•	•
TF10M0C60M	1/4"	60°		M	•	•																			•		•	•
TF10M0D60M	3/8"	60°		M	•	•																			•		•	•
TF10M0B70M-1	3/16"	70°		M	•	•																			•		•	•
TF10M0C70M	1/4"	70°		M	•	•																			•		•	•
TF10M0D70M	3/8"	70°		M	•	•																			•		•	•

1. Damping
 S - Standard Undamped Transducer
 H - Highly Damped Transducer
 R - Resolution Transducer

CT - Damped Coating Thickness Transducer
 M - Medium Damped Transducer
 HG - High Gain Damping Transducers
 HR - High Resolution Transducer

2. High temperature probes suitable for measuring 343°C (650°F)
 3. High temperature probes suitable for measuring 482°C (900°F)

Mini Angle Beam Potted - Mini Transducers

An extra small potted transducer solution



Part Number	Probe Diameter	Angle	Probe Characteristic	Damping ¹	Connection				Suitable for measuring																					
					Microdot	UHF	Top	Side	Cast Iron	Plastics	Thin Plastics	Fibreglass	Thin Fibreglas	Steel	Glass	Aluminium	Titanium	All Metals	Common Metals	Rough Surfaces	Castings	Billets	Extruded Parts	Weld Inspection	Weld Inspection (Tight Areas)	Immersion & Bubbler Inspections	FD700+	FD700DL+		
5.00 MHz Mini Angle Beam Potted - Mini Transducers																														
TF5M00B45M-2	3/16"	45°		M	•			•																		•			•	•
TF5M00B60M-2	3/16"	60°		M	•			•																		•			•	•
TF5M00B70M-2	3/16"	70°		M	•			•																		•			•	•
10.00 MHz Mini Angle Beam Potted - Mini Transducers																														
TF10M0B45M-2	3/16"	45°		M	•			•																		•			•	•
TF10M0B60M-2	3/16"	60°		M	•			•																		•			•	•
TF10M0B70M-2	3/16"	70°		M	•			•																		•			•	•

1. Damping
 S - Standard Undamped Transducer
 H - Highly Damped Transducer
 R - Resolution Transducer

CT - Damped Coating Thickness Transducer
 M - Medium Damped Transducer
 HG - High Gain Damping Transducers
 HR - High Resolution Transducer

2. High temperature probes suitable for measuring 343°C (650°F)
 3. High temperature probes suitable for measuring 482°C (900°F)

Transducer Wedges

Specifications

A range of versatile wedges available in 45°, 60° and 70° angles for use with Elcometer NDT shear wave transducers.



Wedge - Standard Transducers

Angle beam wedge for standard shear wave transducers.

Part Number	Probe Diameter	Angle	Suitable for	
			FD700+	FD700DL+
Wedge - Standard Transducers				
TF9999EE45	1/2 x 1/2"	45°	•	•
TF9999EH45	1/2 x 1"	45°	•	•
TF9999FF45-2	5/8 x 5/8"	45°	•	•
TF9999EE60	1/2 x 1/2"	60°	•	•
TF9999EH60	1/2 x 1"	60°	•	•
TF9999FF60-2	5/8 x 5/8"	60°	•	•
TF9999EE70	1/2 x 1/2"	70°	•	•
TF9999EH70	1/2 x 1"	70°	•	•
TF9999FF70-2	5/8 x 5/8"	70°	•	•

Wedge - Standard Quick Change Transducers

Angle beam wedge designed for quick change transducers

Part Number	Probe Diameter	Angle	Suitable for	
			FD700+	FD700DL+
Wedge - Standard Quick Change Transducers				
TF9999C45-2	1/4"	45°	•	•
TF9999D45-2	3/8"	45°	•	•
TF9999E45-2	1/2"	45°	•	•
TF9999C60-2	1/4"	60°	•	•
TF9999D60-2	3/8"	60°	•	•
TF9999E60-2	1/2"	60°	•	•
TF9999C70-2	1/4"	70°	•	•
TF9999D70-2	3/8"	70°	•	•
TF9999E70-2	1/2"	70°	•	•

Wedge - Mini Shear Wave Transducers

Angle beam wedge for use with mini shear wave transducers.

Part Number	Probe Diameter	Angle	Suitable for	
			FD700+	FD700DL+
Wedge - Mini Shear Wave Transducers				
TF9999A45	1/8"	45°	•	•
TF9999C45-1	1/4"	45°	•	•
TF9999D45-1	3/8"	45°	•	•
TF9999E45-1	1/2"	45°	•	•
TF9999A60	1/8"	60°	•	•
TF9999C60-1	1/4"	60°	•	•
TF9999D60-1	3/8"	60°	•	•
TF9999E60-1	1/2"	60°	•	•
TF9999A70	1/8"	70°	•	•
TF9999C70-1	1/4"	70°	•	•
TF9999D70-1	3/8"	70°	•	•
TF9999E70-1	1/2"	70°	•	•

Wedge - Snail Transducers

Angle beam wedge meeting American Welding society standards for use with standard shear wave transducers.

Part Number	Probe Diameter	Angle	Suitable for	
			FD700+	FD700DL+
Wedge - Snail Transducers				
TF9999FF45-1	5/8 x 5/8"	45°	•	•
TF9999FF60-1	5/8 x 5/8"	60°	•	•
TF9999FF70-1	5/8 x 5/8"	70°	•	•

Elcometer NDT offer a full range of bolt gauge transducers to ultrasonically measure the actual elongation produced by tightening a threaded fastener.



Part Number	Probe Diameter	Element Type	Probe Characteristic	Damping	Connector Type					Suitable for measuring								Suitable for			
					Potted	Microdot	Lemo	Top	Side	End	All Metals	Common Metals	Rough Surfaces	Castings	Billets	Extruded Parts	Weld Inspection	Weld Inspection (Tight Areas)	Immersion & Bubbler Inspections	FD700+	FD700DL+
2.25 MHz Bolt Gauge Transducers																					
TX2M25CM-5	1/4"	Si/EI Non-Magnetic	Standard	S	•	•			•										•	•	
TX2M25CM-6	1/4"	Si/EI Magnetic	Standard	S	•	•			•										•	•	
TX2M25DM	3/8"	Si/EI Magnetic	Standard	S	•	•			•										•	•	
TX2M25EM-5	1/2"	Si/EI Non-Magnetic	Standard	S	•	•			•										•	•	
TX2M25EM-6	1/2"	Si/EI Magnetic	Standard	S	•	•			•										•	•	
TX2M25GM	3/4"	Si/EI Magnetic	Standard	S	•	•			•										•	•	
5.00 MHz Bolt Gauge Transducers																					
TX5M00AM-2	1/8"	Si/EI Non-Magnetic	Standard	S	•	•			•										•	•	
TX5M00AM-3	1/8"	Si/EI Magnetic	Standard	S	•	•			•										•	•	
TX5M00CM-7	1/4"	Si/EI Non-Magnetic	Standard	S	•	•			•										•	•	
TX5M00CM-8	1/4"	Si/EI Magnetic	Standard	S	•	•			•										•	•	
TX5M00DM	3/8"	Si/EI Magnetic	Standard	S	•	•			•										•	•	
TX5M00EM-7	1/2"	Si/EI Magnetic	Standard	S	•	•			•										•	•	
TX5M00EM-6	1/2"	Si/EI Non-Magnetic	Standard	S	•	•			•										•	•	
TX5M00GM	3/4"	Si/EI Magnetic	Standard	S	•	•			•	•	•	•	•					•	•	•	•
10.00 MHz Bolt Gauge Transducers																					
TX10M0AM-2	1/8"	Si/EI Non-Magnetic	Standard	S	•	•			•										•	•	
TX10M0AM-3	1/8"	Si/EI Magnetic	Standard	S	•	•			•										•	•	
TX10M0CM-4	1/4"	Si/EI Non-Magnetic	Standard	S	•	•			•										•	•	
TX10M0CM-5	1/4"	Si/EI Magnetic	Standard	S	•	•			•										•	•	

1. Damping
 S - Standard Undamped Transducer
 H - Highly Damped Transducer
 R - Resolution Transducer

CT - Damped Coating Thickness Transducer
 M - Medium Damped Transducer
 HG - High Gain Damping Transducers
 HR - High Resolution Transducer

2. High temperature probes suitable for measuring 343°C (650°F)
 3. High temperature probes suitable for measuring 482°C (900°F)

Accessories

Specifications

Elcometer NDT offer a comprehensive range of accessories for all the ultrasonic NDT gauges and transducers.



Part Number	Description	Suitable for																								
		CG10	CG20	CG30	CG50	CG50DL	CG60	CG60DL	CG70BDL	CG70ABDL	CG100B	CG100BDL	CG100ABDL	CG100ABDL+	UG20DL	PG70	PG70DL	PG70ABDL	FD700+	FD700DL+	VG10	SG80	SG80BDL	BG80DL	BG80TDL	
Couplant																										
TC-24034-1	Couplant: Standard; 4oz Bottle	•	•	•	•	•	•	•	•	•	•	•	•	•	•	•	•	•	•	•	•	•	•	•	•	•
TC-24034-2	Couplant: Standard; 12oz Bottle	•	•	•	•	•	•	•	•	•	•	•	•	•	•	•	•	•	•	•	•	•	•	•	•	•
TC-24034-3	Couplant: Standard; 1 Gallon	•	•	•	•	•	•	•	•	•	•	•	•	•	•	•	•	•	•	•	•	•	•	•	•	•
TC-24034-4	Couplant: Hi-Temp 343°C (650°F); 2oz Tube	•	•	•	•	•	•	•	•	•	•	•	•	•	•	•	•	•	•	•	•	•	•	•	•	•
TC-24034-5	Couplant: Hi-Temp 482°C (900°F); 2oz Tube	•	•	•	•	•	•	•	•	•	•	•	•	•	•	•	•	•	•	•	•	•	•	•	•	•
TC-24034-6	Underwater Gasket Lubricant, 6g														•											
Delay Lines																										
TD-24033-1	Cone Tip Delay Line: Acrylic; 1/8"																•	•	•	•	•					
TD-24033-2	Cone Tip Delay Line: Acrylic; 3/16"																•	•	•	•	•					
TD-24033-3	Cone Tip Delay Line: Graphite; 3/16"																•	•	•	•	•					
TD-24033-4	Delay Line Tip (Pencil): Acrylic; 1/16" Dia x 0.45" L																•	•	•	•	•					
TD-24033-5	Delay Line Tip (Pencil): Acrylic; 1/8" Dia x 0.45" L																•	•	•	•	•					
TD-24033-6	Delay Line Tip: Acrylic; 1/4" Dia x 1/2" L																•	•	•	•	•					
TD-24033-7	Delay Line Tip: Acrylic; 1/4" Dia x 3/8" L																•	•	•	•	•					
TD-24033-8	Delay Line Tip: Graphite; 1/4"																•	•	•	•	•					
Cables & Adaptors																										
TL-24030-1	T/Cable: 1.2m (4') Single Lemo 00 to BNC											•	•	•	•				•	•	•					
TL-24030-2	T/Cable: 1.2m (4') Single Lemo 00 to Lemo 00											•	•	•	•				•	•	•					
TL-24030-3	T/Cable: 1.2m (4') Single Lemo 00 to Microdot											•	•	•	•			•	•	•	•			•	•	
TL-24030-4	T/Cable: 1.2m (4') Single Lemo UW to Lemo UW															•										
TL-24030-5	T/Cable: 1.2m (4') Dual Lemo 00 to BNC																			•	•					
TL-24030-6	T/Cable: 1.2m (4') Dual Lemo to Lemo	•	•	•	•	•	•	•	•	•	•	•	•	•	•					•	•					
TL-24030-7	T/Cable: 1.2m (4') Dual Lemo to Microdot	•	•	•	•	•	•	•	•	•	•	•	•	•	•					•	•					
TL-24030-8	T/Cable: 1.2m (4') Dual Lemo to Microdot Single											•	•	•						•	•					
TL-24030-13	T/Cable: 1.2m (4') Dual Lemo to M/dot, Armoured	•	•	•	•	•	•	•	•	•	•	•	•	•	•											
TL-24030-9	T/Cable: 1.2m (4') Dual Lemo to M/dot, HT Armoured	•	•	•	•	•	•	•	•	•	•	•	•	•	•											
TL-24030-10	T/Cable: 3m (10') Single Lemo to Microdot																							•	•	
TL-24030-11	T/Cable: 6m (20') Single Lemo to Microdot Single																							•	•	
TL-24030-12	T/Cable: 6m (20') Lemo to Lemo 00																							•	•	
TL-24031	RS232 Cable 1.8m (6'); DB-9 to Lemo	•	•	•	•	•	•	•	•	•	•	•	•	•	•	•	•	•	•	•	•	•	•	•	•	
TL-24032	USB to Serial Converter	•	•	•	•	•	•	•	•	•	•	•	•	•	•	•	•	•	•	•	•	•	•	•	•	
Accessories																										
TZ-24035	6" Ext Wand for S/E Microdot Transducers																		•	•	•	•				
TZ-24036	Temperature Sensor with 1.8m (6') Cable																							•	•	
TZ-24037	O-Ring Kit (1 Lubricant & 2 Gaskets)																•									
TZ-24038	Spring Loaded Probe Holder (V-Block)																						•	•		
TZ-24039	Hammer Transducer (Cylinder Kit)																						•	•		

Elcometer NDT offer a comprehensive range of calibration blocks to suit a wide range of applications and standards.



Selecting the right calibration block

Selecting the correct calibration block for your application is essential to ensure accurate evaluation.

The form, shape and material of the calibration block should be appropriate for the material being inspected. Any artificially induced flaw should closely resemble that of the actual flaw being tested for.

Elcometer NDT offer a full range of standard calibration blocks, for more information contact Elcometer.

Block Type	Steel 4340	Steel	7075 AL	304 SS	Titanium	Glass
4 Step Block (ASTM E-797) Thickness and linearity calibration	•	•	•	•	•	
5 Step Block (ASTM E-797) Thickness and linearity calibration	•	•	•	•	•	
10 Step Block (ASTM E-797) Thickness and linearity calibration	•	•	•	•	•	
IIW Type 1 (IIW, ASTM E-164 & MIL-STD-2154)		•	•	•	•	
IIW Type 2 (IIW & USAFTO 33 B1-1-1 (6-1-84))		•	•	•	•	
IIW V-1 (Metric BS 2704)		•	•	•	•	
Mini IIW		•	•	•	•	
DSC (AWS & ASTM E-164) Shear wave distance & sensitivity calibration		•	•	•	•	
DS (ANSI & AWS) Distance & sensitivity		•	•	•	•	
Angle Beam ROMPAS (ASTM E-164 & USAFTO 33 B-1-1) Angle beam calibration		•	•	•	•	
Angle Beam (Metric) Angle beam calibration		•	•	•	•	
ANSI/AWS Resolution - RC Resolution capabilities of angle beam transducers		•	•	•	•	
SC (AWS & ASTM E-164) Sensitivity calibration (shear wave)		•	•	•	•	
DC (AWS & ASTM E-164) Distance calibration (shear wave)		•	•	•	•	
IOW Beam Profile (BS2704) Beam profile measurement of angle beam transducer		•	•	•	•	
NAVSHIPS (NAVSEA T 9074-AS-GIB-010/271) Distance correction and sensitivity levels		•	•	•	•	
ASME ref.block 0"-1" (ASME SEC V Article 23 T-534.2.1) Angle beam calibration		•	•	•	•	
ASME ref.block 1"-2" (ASME SEC V Article 23 T-534.2.1) Angle beam calibration		•	•	•	•	
ASME ref.block 2"-4" (ASME SEC V Article 23 T-534.2.1) Angle beam calibration		•	•	•	•	
ASME-N-625 ref. plate (ASME 1275N B.P., Section 3, Nuclear Vessels) Longitudinal shear and surface wave sensitivity calibration		•	•	•	•	
Glass Calibration Block; 1, 2 & 3"						•



Corrosion Gauges



Precision Gauges



Flaw Detection



Velocity Gauges



Sonic Gauges



Bolt Gauges

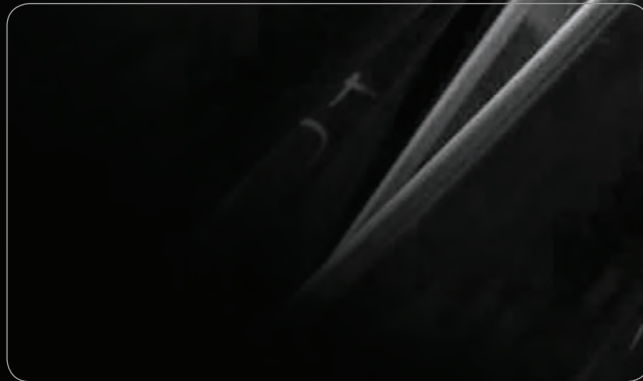

elcometer[®] NDT

www.elcometerndt.com

ENGLAND

Elcometer Limited
Manchester M43 6BU
Tel: +44 (0)161 371 6000
Fax: +44 (0)161 371 6010
e-mail: sales@elcometer.com

USA

Elcometer Inc
Rochester Hills Michigan 48309
Tel: +1 248 650 0500
Toll Free: 800 521 0635
Fax: +1 248 650 0501
e-mail: inc@elcometer.com

REPUBLIC OF SINGAPORE

Elcometer (Asia) Pte Ltd
Singapore 589472,
Tel: +65 6462 2822
Fax: +65 6462 2860
e-mail: asia@elcometer.com

JAPAN

Elcometer KK
Minato-ku, Tokyo
Tel: +81 (0)3-4530-9714
Fax: +81 (0)3-4530-9713
e-mail: jp_info@elcometer.com

FRANCE

Elcometer Sarl
45430 BOU
Tel: +33 (0)2 38 86 33 44
Fax: +33 (0)2 38 91 37 66
e-mail: fr_info@elcometer.com

GERMANY

Elcometer Instruments GmbH
D-73431 Aalen
Tel: +49(0)7361 52806 0
Fax: +49(0)7361 52806 77
e-mail: de_info@elcometer.de

BELGIUM

Elcometer SA
B-4681 Hermalle /s Argenteau
Tel: +32 (0)4 379 96 10
Fax: +32 (0)4 374 06 03
e-mail: be_info@elcometer.com

THE NETHERLANDS

Elcometer NL
3584 BH Utrecht
Tel: +31 (0)30 210.7005
Fax: +31 (0)30 210.6666
email: nl_info@elcometer.com